

**Nikon**

**En**

The Nikon Guide to Digital Photography  
with the

# **COOLPIX 8700**

**DIGITAL CAMERA**



**CE**



### Attaching the Camera Strap

Attach the camera strap as shown below. Repeat for the second eyelet.

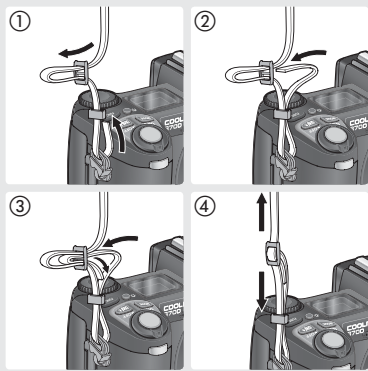

### The Lens Cap

When replacing or removing the lens cap, press the tabs on either side of the cap to release the latch.

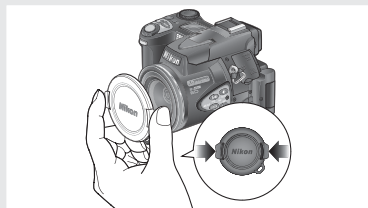

To avoid losing the lens cap, use the cord provided to attach it to the camera as shown.

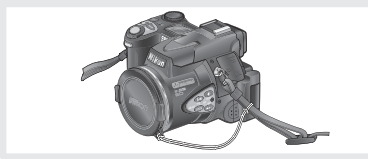

### Trademark Information

Apple, the Apple logo, Macintosh, Mac OS, Power Macintosh, PowerBook, and Quick Time are registered trademarks of Apple Computer, Inc. Finder, Power Mac, iMac, and iBook are trademarks of Apple Computer, Inc. Microsoft and Windows are registered trademarks of Microsoft Corporation. Internet is a trademark of Digital Equipment Corporation. CompactFlash is a trademark of SanDisk Corporation. Lexar Media is a trademark Lexar Media Corporation. Microdrive is a registered trademark of Hitachi Global Storage Technologies in the United States and/or other countries. Adobe and Acrobat are registered trademarks of Adobe Systems Inc. PictBridge is a trademark. All other trade names mentioned in this manual or the other documentation provided with your Nikon product are trademarks or registered trademarks of their respective holders.

## Symbols and Conventions

To make it easier to find the information you need, the following symbols and conventions are used:



This icon marks cautions, information that should be read before use to prevent damage to the camera.



This icon marks notes, information that should be read before using the camera.



This icon marks tips, additional information that may be helpful when using the camera.



This icon indicates that more information is available elsewhere in this manual or in the *Quick Start Guide*.

## Introduction



## First Steps



## Basic Photography



## Scene Mode



## More on Photography



## Movies



## More on Playback



## Menu Guide



## Technical Notes



# For Your Safety

To prevent damage to your Nikon product or injury to yourself or to others, read the following safety precautions in their entirety before using this equipment. Keep these safety instructions where all those who use the product will read them.

The consequences that could result from failure to observe the precautions listed in this section are indicated by the following symbol:



This icon marks warnings, information that should be read before using this Nikon product to prevent possible injury.

## WARNINGS



### **Do not look at the sun through the viewfinder**

Viewing the sun or other strong light source through the viewfinder could cause permanent visual impairment.



### **Turn off immediately in the event of malfunction**

Should you notice smoke or an unusual smell coming from the equipment or from the AC adapter (available separately), unplug the AC adapter and remove the battery immediately, taking care to avoid burns. Continued operation could result in injury. After removing the battery, take the equipment to a Nikon-authorized service representative for inspection.



### **Do not use in the presence of flammable gas**

Do not use electronic equipment in the presence of flammable gas, as this could result in explosion or fire.



### **Observe caution when using the camera strap**

Never place the strap around the neck of an infant or child.



### **Do not disassemble**

Touching the product's internal parts could result in injury. In the event of malfunction, the product should be repaired only by a qualified technician. Should the product break open as the result of a fall or other accident, take the product to a Nikon-authorized service representative for inspection after unplugging the AC adapter and removing the battery.



### **Observe proper precautions when handling batteries**

Batteries may leak or explode if improperly handled. Observe the following precautions when handling batteries for use in this product:

- Before replacing the battery, turn the product off and make sure the power-on lamp has gone out. If you are using an AC adapter, be sure it is unplugged.
- Use only rechargeable Nikon EN-EL1 lithium-ion batteries (supplied) or six-volt 2CR5 (DL245) lithium batteries (available separately).
- When inserting the battery, do not attempt to insert it upside down or backwards.
- Do not short or disassemble batteries.
- Do not expose batteries to flame or to excessive heat.



- Do not immerse in or expose to water.
- Replace the terminal cover when transporting the battery. Do not transport or store with metal objects such as necklaces or hairpins.
- Batteries are prone to leakage when fully discharged. To avoid damage to the product, be sure to remove the battery when no charge remains.
- Immediately after use, or when the product is used on battery power for an extended period, the battery may become hot. Before removing the battery, turn the camera off and allow the battery to cool.
- The camera grip may become noticeably warm when the camera is used with a 2CR5 (DL245) lithium battery. This is normal and does not indicate a malfunction.
- Discontinue use immediately should you notice any change in the battery, such as discoloration or deformation.



#### **Use appropriate cables**

When connecting cables to the input and output jacks, use only the cables provided or sold by Nikon for the purpose, to maintain compliance with product regulations.



#### **Keep out of reach of children**

Particular care should be taken to prevent infants from putting the batteries or other small parts into their mouths.



#### **Removing memory cards**

Memory cards may become hot during use. Observe due caution when removing memory cards from the camera.



#### **CD-ROMs**

The CD-ROMs on which the software and manuals are distributed should not be played back on audio CD equipment. Playing CD-ROMs on an audio CD player could cause hearing loss or damage the equipment.



#### **Observe caution when operating the flash**

Using the flash close to your subject's eyes could cause temporary visual impairment. Particular care should be observed if photographing infants, when the flash should be no less than one meter (39") from the subject.



#### **When using the viewfinder**

When operating the diopter adjustment control with your eye to the viewfinder, care should be taken to not put your finger in your eye accidentally.



#### **Avoid contact with liquid crystal**

Should the monitor break, care should be taken to avoid injury due to broken glass and to prevent liquid crystal from the monitor touching the skin or entering the eyes or mouth.

# Notices

- No part of the manuals included with this product may be reproduced, transmitted, transcribed, stored in a retrieval system, or translated into any language in any form, by any means, without Nikon's prior written permission.
- Nikon reserves the right to change the specifications of the hardware and software described in these manuals at any time and without prior notice.
- Nikon will not be held liable for any damages resulting from the use of this product.
- While every effort has been made to ensure that the information in these manuals is accurate and complete, we would appreciate it were you to bring any errors or omissions to the attention of the Nikon representative in your area (address provided separately).

## Notice for customers in the U.S.A.

### Federal Communications Commission (FCC) Radio Frequency Interference Statement

This equipment has been tested and found to comply with the limits for a Class B digital device, pursuant to Part 15 of the FCC rules. These limits are designed to provide reasonable protection against harmful interference in a residential installation. This equipment generates, uses, and can radiate radio frequency energy and, if not installed and used in accordance with the instructions, may cause harmful interference to radio communications. However, there is no guarantee that interference will not occur in a particular installation. If this equipment does cause harmful interference to radio or television reception, which can be determined by turning the equipment off and on, the user is encouraged to try to correct the interference by one or more of the following measures:

- Reorient or relocate the receiving antenna.
- Increase the separation between the equipment and receiver.
- Connect the equipment into an outlet on a circuit different from that to which the receiver is connected.
- Consult the dealer or an experienced radio/television technician for help.



### CAUTIONS

#### Modifications

The FCC requires the user to be notified that any changes or modifications made to this device that are not expressly approved by Nikon Corporation may void the user's authority to operate the equipment.

#### Interface Cables

Use the interface cables sold or provided by Nikon for your equipment. Using other interface cables may exceed the limits of Class B Part 15 of the FCC rules.

#### Notice for customers in the State of California

**WARNING:** Handling the cord on this product will expose you to lead, a chemical known to the State of California to cause birth defects or other reproductive harm. *Wash hands after handling.*

Nikon Inc.,  
1300 Walt Whitman Road, Melville, New York  
11747-3064, U.S.A. Tel.: 631-547-4200

## **Notice for customers in Canada**

### **CAUTION**

This class B digital apparatus meets all requirements of the Canadian Interference Causing Equipment Regulations.

### **ATTENTION**

Cet appareil numérique de la classe B respecte toutes les exigences du Règlement sur le matériel brouilleur du Canada.

## **Notice Concerning Prohibition of Copying or Reproduction**

Note that simply being in possession of material that has been digitally copied or reproduced by means of a scanner, digital camera or other device may be punishable by law.

### **• Items prohibited by law from being copied or reproduced**

Do not copy or reproduce paper money, coins, securities, government bonds, or local government bonds, even if such copies or reproductions are stamped "Sample."

The copying or reproduction of paper money, coins, or securities which are circulated in a foreign country is prohibited.

Unless the prior permission of the government has been obtained, the copying or reproduction of unused postage stamps or post cards issued by the government is prohibited.

The copying or reproduction of stamps issued by the government and of certified documents stipulated by law is prohibited.







### **• Cautions on certain copies and reproductions**

The government has issued cautions on copies or reproductions of securities issued by private companies (shares, bills, checks, gift certificates, etc.), commuter passes, or coupon tickets, except when a minimum of necessary copies are to be provided for business use by a company. Also, do not copy or reproduce passports issued by the government, licenses issued by public agencies and private groups, ID cards, and tickets, such as passes and meal coupons.

### **• Comply with copyright notices**

The copying or reproduction of copyrighted creative works such as books, music, paintings, woodcut prints, maps, drawings, movies, and photographs is governed by national and international copyright laws. Do not use this product for the purpose of making illegal copies or to infringe copyright laws.

# Table of Contents

For Your Safety .....	ii
Notices .....	iv
<b>Introduction</b> .....	<b>1</b>
Parts of the Camera .....	2
Using the Monitor .....	4
Camera Displays .....	5
Turning the Camera on and Off .....	7
The Shutter-Release Button .....	7
Navigating the Menus .....	7
<b>First Steps</b> .....	<b>8</b>
Inserting Batteries .....	8
Inserting Memory Cards .....	10
Basic Setup .....	11
<b>Basic Photography</b> .....	<b>14</b>
Step 1—Select  Mode .....	14
Step 2—Frame the Picture .....	16
Step 3—Focus and Shoot .....	18
Step 4—View the Results (Quick review/Full-screen review) .....	21
<b>Scene Mode</b> .....	<b>23</b>
Taking Pictures in Scene Mode .....	23
Taking Pictures for a Panorama .....	28
<b>More on Photography</b> .....	<b>30</b>
Image Quality and Size .....	30
Image Quality .....	30
Image Size .....	32
Flash Mode .....	34
Focus Mode .....	37
Self-Timer Mode .....	38
Exposure Compensation .....	39
Exposure Mode (Shooting Modes  [Custom 1] and  [Custom 2] Only) .....	40
P: Programmed Auto .....	41
S: Shutter-Priority Auto .....	42
A: Aperture-Priority Auto .....	43
M: Manual .....	44
Sensitivity (Shooting Modes  [Custom 1] and  [Custom 2] Only) .....	46
Manual Focus (Shooting Modes  [Custom 1] and  [Custom 2] Only) .....	47

<b>Movies</b>	49
Movie Options (Shooting Modes <b>1</b> [Custom 1] and <b>2</b> [Custom 2] Only)....	49
Recording Movies .....	51
Recording a Time-Lapse Movie .....	52
Viewing Movies .....	54
<b>More on Playback</b>	55
Viewing Pictures on the Camera .....	55
Full-Frame Playback .....	55
Viewing Multiple Pictures: Thumbnail Playback .....	57
Photo Information .....	58
Taking a Closer Look: Playback Zoom.....	60
Creating Small Copies: Small Picture .....	62
Voice Memos: Recording and Playback .....	63
Viewing Pictures on TV .....	64
Viewing Pictures on a Computer .....	65
Printing Pictures .....	68
Printing Via Direct USB Connection.....	69
<b>Menu Guide</b>	74
The Shooting Menu (Shooting Modes <b>1</b> [Custom 1] and <b>2</b> [Custom 2] Only) ...	74
White Balance .....	76
Metering .....	79
Continuous .....	80
Best Shot Selector (BSS).....	84
Image Adjustment .....	86
Saturation Control.....	87
User Setting.....	88
Image Sharpening .....	89
Lens .....	90
Exposure Options .....	91
Focus Options.....	93
Zoom Options .....	95
Speedlight Options .....	96
Auto Bracketing .....	99
Noise Reduction .....	101
Reset.....	102
My Menu .....	103
CF Card Format .....	104

<b>The Playback Menu</b> .....	105
Delete .....	106
Folders .....	108
Slide Show .....	112
Protect .....	114
Hide Image.....	115
Print Set .....	116
Auto Transfer .....	118
Move Image .....	120
CF Card Format .....	121
Small Pic.....	121
<b>The Setup Menu</b> .....	122
Language .....	124
Date.....	124
Folders .....	126
Monitor Options.....	126
Seq. Numbers.....	129
Shutter Sound .....	130
Auto Off.....	131
CF Card Format .....	131
Controls .....	132
Shot Confirmation.....	133
info.txt .....	134
USB .....	134
Video Mode .....	135
Reset All.....	135
Date Imprint.....	136
Firmware Version.....	136
<b>Technical Notes</b> .....	137
Optional Accessories .....	137
Approved Memory Cards.....	139
Caring for Your Camera .....	140
Error Messages.....	143
Troubleshooting .....	146
Specifications.....	149
<b>Index</b> .....	151

# Introduction



Thank you for your purchase of a Nikon COOLPIX 8700 digital camera. This manual has been written to help you enjoy taking pictures with your Nikon digital camera. Read this manual thoroughly before use, and keep it where all those who use the product will read it.

## Before Taking Important Pictures

Before taking pictures on important occasions (such as at weddings or before taking the camera on a trip), take a test shot to ensure that the camera is functioning normally. Nikon will not be held liable for damages or lost profits that may result from product malfunction.

## Life-Long Learning

As part of Nikon's "Life-Long Learning" commitment to ongoing product support and education, continually-updated information is available on-line at the following sites:

- For users in the U.S.A.: <http://www.nikonusa.com/>
  - For users in Europe: <http://www.europe-nikon.com/support>
  - For users in Asia, Oceania, the Middle East, and Africa: <http://www.nikon-asia.com/>
- Visit these sites to keep up-to-date with the latest product information, tips, answers to frequently-asked questions (FAQs), and general advice on digital imaging and photography. Additional information may be available from the Nikon representative in your area. See the URL below for contact information:

<http://nikonimaging.com/>

### **Use Only Nikon Brand Electronic Accessories**

Nikon COOLPIX cameras are designed to the highest standards and include complex electronic circuitry. Only Nikon brand electronic accessories (including battery chargers, batteries, AC adapters, and Speedlights) certified by Nikon specifically for use with this Nikon digital camera are engineered and proven to operate within the operational and safety requirements of this electronic circuitry.

THE USE OF NON-NIKON ELECTRONIC ACCESSORIES COULD DAMAGE THE CAMERA AND MAY VOID YOUR NIKON WARRANTY. The use of third-party rechargeable Li-ion batteries not approved by Nikon could interfere with normal operation of the camera or result in the batteries overheating, igniting, rupturing, or leaking.

For more information about Nikon brand accessories, contact a local authorized Nikon dealer.

# Parts of the Camera

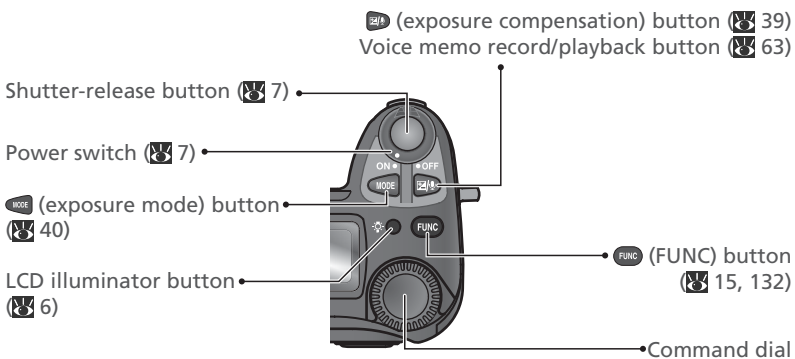
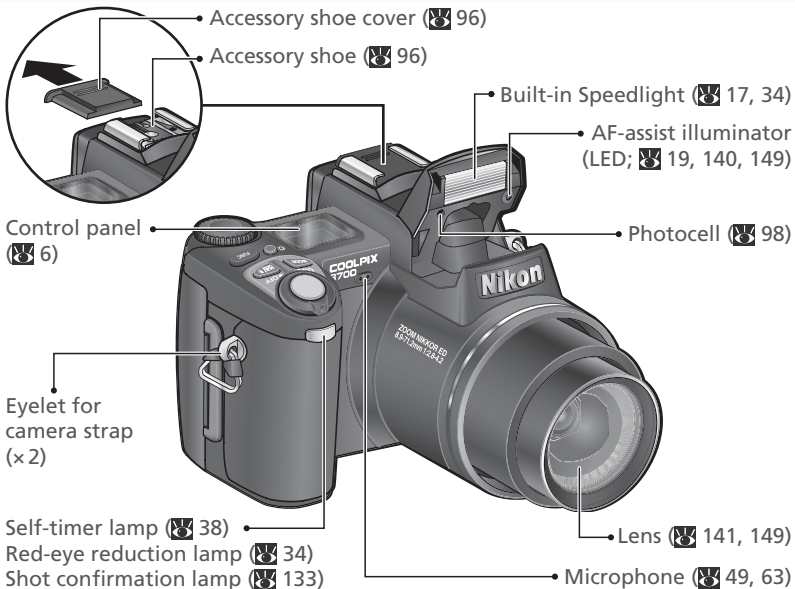



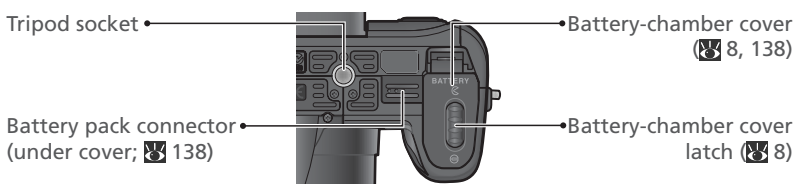
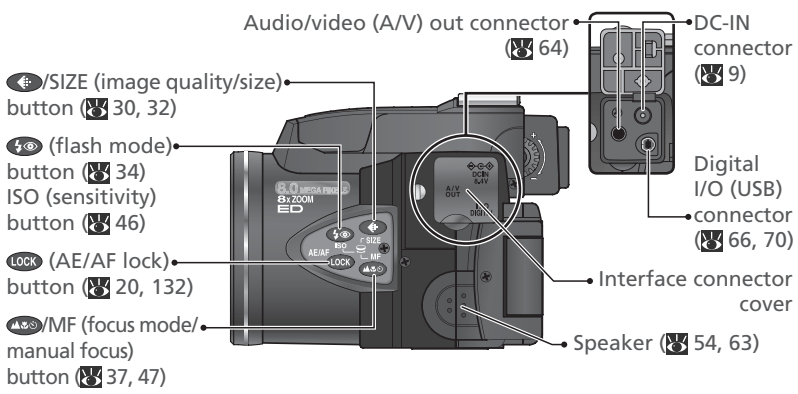
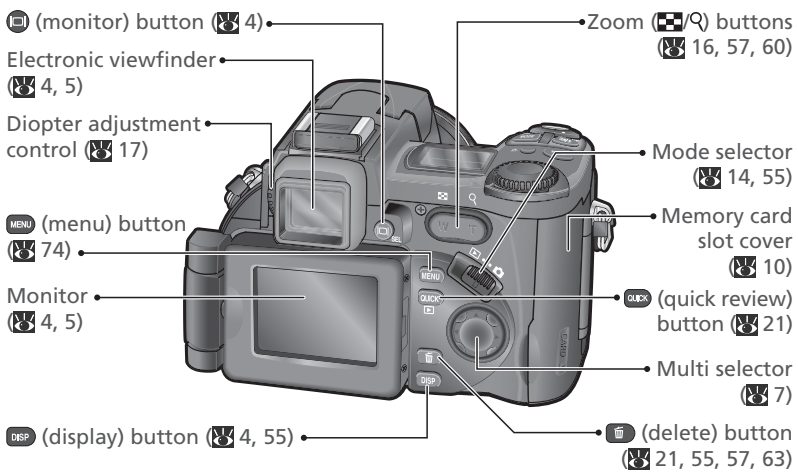

# Using the Monitor



Fold out to use

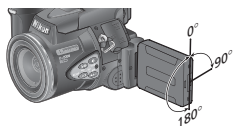

Range of rotation



Frame self-portraits\*



Stow on camera body



Storage position†



\* Monitor shows mirror image of what will appear in final picture.

† If camera is on, monitor turns off and electronic viewfinder turns on automatically.

## ✓ Do Not Use Excessive Force

Do not use excessive force when rotating the monitor. Failure to observe this precaution could damage the hinge connecting the monitor to the camera body.

## 🔊 The and Buttons

The electronic viewfinder can be used to frame pictures when bright ambient lighting conditions make the display in the monitor difficult to see. Use the  button to switch between the monitor and electronic viewfinder. To hide or display indicators in the monitor or electronic viewfinder when the camera is in shooting mode, press the  button.

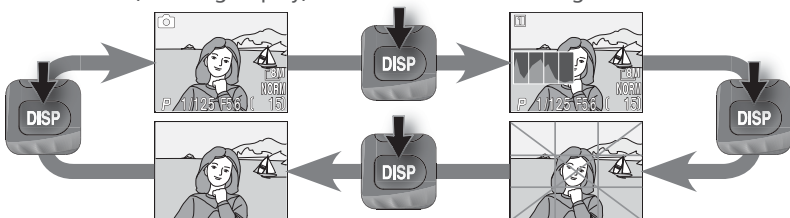

Settings and view through lens  
(shooting display)

Histogram\*



View through lens with battery, flash, and focus indicators only

Framing guides

\* Shooting modes  (Custom 1) and  (Custom 2) only; not displayed in exposure mode **M**, in movie mode, or when AE-lock is in effect.

# Camera Displays

## Monitor/Electronic Viewfinder

The following indicators appear in the monitor and electronic viewfinder during shooting:

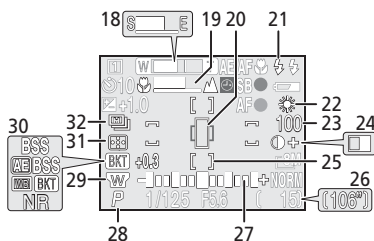
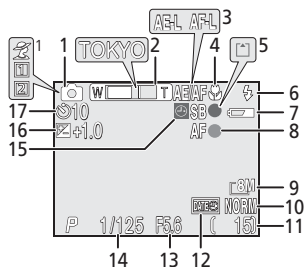

1	Shooting mode.....	15
2	Zoom indicator <sup>2</sup> .....	16
	Folder name .....	22, 108, 126
3	Exposure/focus lock .....	91, 133
4	Focus mode.....	37
5	Flash indicator .....	18
	Recording indicator .....	19
6	Flash mode.....	34
7	Battery level indicator <sup>3</sup> .....	14
8	Focus indicator <sup>4</sup> .....	18
9	Image size .....	32
10	Image quality.....	30
11	Number of exposures remaining.....	14
12	Date imprint indicator.....	136
13	Aperture.....	40, 43
14	Shutter speed.....	40, 42
15	"Date not set" icon <sup>5</sup> .....	12
16	Exposure compensation .....	39
17	Self-timer indicator .....	38

18	Ultra HS recording indicator.....	81
19	Manual focus display .....	47
20	Spot metering target .....	79
21	Flash mode for optional Speedlights.....	97
22	White balance .....	76
23	Sensitivity (ISO equivalency) .....	46
24	Image adjustment.....	86
	Black-and-white indicator .....	87
25	Focus areas.....	93
26	Length of movie .....	51
27	Exposure display .....	44
28	Exposure mode.....	40
29	Converter lens setting.....	90
30	Best Shot Selector (BSS).....	84
	Bracketing indicator.....	99
	Noise reduction .....	101
31	Metering mode .....	79
32	Continuous shooting mode .....	80

1 Icon varies with scene mode selected.

2 Displayed when zoom buttons are pressed.

3 Appears when batteries are running low.

4 Displayed when shutter-release button is pressed halfway.

5 Appears when camera clock has not been set.



## Control Panel<sup>1</sup>

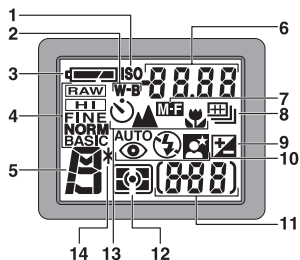

- 1 Sensitivity (ISO equivalency) indicator ..... 46
- 2 White balance indicator (appears when **FUNC** button is used to set white balance) ..... 76
- 3 Battery level indicator ..... 14
- 4 Image quality ..... 30
- 5 Exposure mode ..... 40

<sup>1</sup> Control panel is shown with all elements lit for illustrative purposes.

- 6 Shutter speed<sup>2</sup> ..... 40, 42
- Aperture<sup>2</sup> ..... 40, 43
- Shooting mode ..... 24
- Image size ..... 32
- Exposure compensation ..... 39
- Sensitivity (ISO equivalency) ..... 46
- White balance ..... 76
- Image transfer status ..... 66
- 7 Manual focus indicator ..... 47
- 8 Continuous shooting mode ..... 80
- 9 Exposure compensation indicator ..... 39
- 10 Flash mode ..... 34
- 11 Exposure count display (number of exposures remaining) ..... 14
- Exposure indicator ..... 44
- 12 Metering mode ..... 79
- 13 Self-timer ..... 38
- Focus mode ..... 37
- 14 Flexible Program ..... 41

<sup>2</sup> Press **MODE** button to switch between shutter-speed and aperture displays (**S**, **Z**, **P**, and **M** only).

### The LCD Illuminator Button

To view settings in the dark, press the LCD illuminator button (**L** 2). The LCD illuminator (control panel backlight) will light for about eight seconds.

## Turning the Camera on and Off

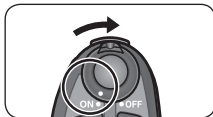

When the camera is turned on, the lens will extend and the monitor or electronic viewfinder will display a welcome message. The message will clear from the display when the camera is ready for shooting or playback.

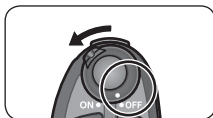

When the camera is turned off, the lens will retract and the camera displays will turn off.

## The Shutter-Release Button

The camera has a two stage shutter-release button. The camera sets focus and exposure when the button is pressed halfway. Focus and exposure will remain locked while the shutter-release button is kept in this position. To take the picture, press the shutter-release button the rest of the way down.

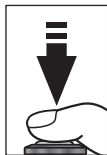
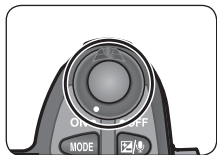

## Navigating the Menu

The multi selector is used to navigate through the camera menus.

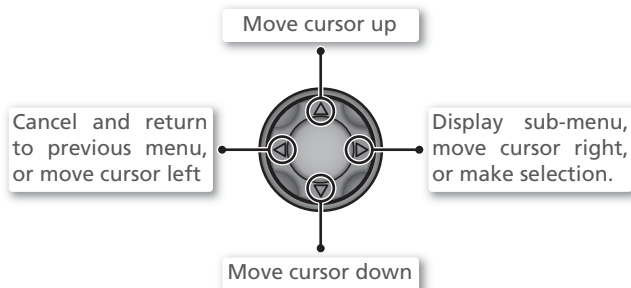

# First Steps

## Inserting Batteries

The camera uses either of the following batteries:

Battery	Description
Rechargeable Nikon EN-EL1 lithium-ion batteries (x1)	<ul style="list-style-type: none"><li>• Provided with camera</li><li>• Can be recharged using supplied MH-53 battery charger (be sure to charge battery before using camera for first time or after long period of disuse). About two hours are required to charge battery when no charge remains.</li></ul>
Six-volt 2CR5 (DL245) lithium batteries (x1)	<ul style="list-style-type: none"><li>• Available at many retail outlets</li><li>• Not rechargeable</li></ul>



**1** Turn the camera off

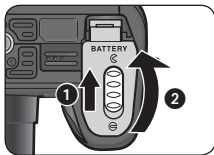

**2** Open the battery-chamber cover  
Slide the battery-chamber cover latch to the ☞ position (1) and flip the battery-chamber cover open (2).

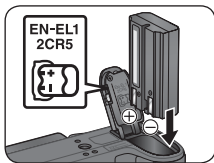

EN-EL1

**3** Insert the battery  
Insert the battery as shown in the label inside the battery-chamber cover.

### ✓ Inserting Batteries

Inserting the battery upside down or backwards could damage the camera. Check to be sure the battery is in the correct orientation.

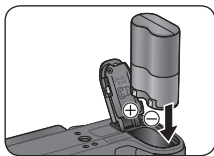

2CR5 (DL245)

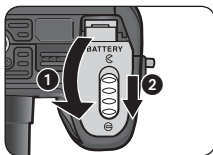

- 4** Close the battery-chamber cover  
 Close the battery-chamber cover (1) and slide the latch to the E position (2).

### Replacing Batteries

*Turn the camera off* before removing or inserting batteries. To remove the battery, open the battery-chamber cover as described in Step 2, above, and slide the battery out. Note that the battery may become hot during use; observe due caution when removing the battery.

### Read Battery Warnings

*Read and follow the battery warnings and cautions on pages ii–iii and 140 of this manual, together with any warnings and instructions supplied by the battery manufacturer.*

### Alternative Power Sources

To power the camera continuously for extended periods, use an EH-53 AC adapter (available separately; 137). **Do not, under any circumstances, use another make or model of AC adapter.** Failure to observe this precaution could result in overheating or in damage to the camera.

# Inserting Memory Cards

The camera stores pictures on CompactFlash™ memory cards. See “Technical Notes: Approved Memory Cards” (139) for a list of compatible cards.

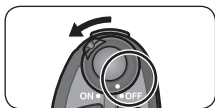

**1** Turn the camera off

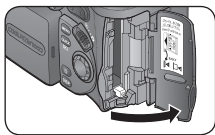

**2** Open the memory card slot cover  
A yellow notice detailing memory card insertion is placed in the memory card slot at shipment. Remove the notice and read the instructions.

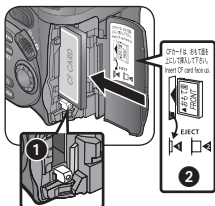

**3** Insert a memory card  
Check that the eject button is all the way down (1) and then insert a memory card as shown in the label inside the memory card slot cover (2).

## Inserting Memory Cards

Insert memory cards terminals first. Inserting the card upside down or backwards could damage the camera or the card. Check to be sure the card is in the correct orientation.

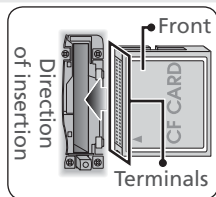

## The Eject Button

If the eject button is up when the card-slot cover is closed, closing the cover will partially eject the memory card, causing errors when the camera is turned on. Be sure the eject button is down before inserting memory cards.

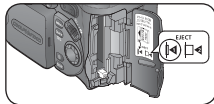

## Removing Memory Cards

Memory cards can be removed without loss of data when the camera is off. To remove memory cards, turn the camera off and open the memory card slot cover. Press the eject button to pop it up (1), then press it again to partially eject the card (2). The card can then be removed by hand. Note that memory cards may become hot during use; observe due caution when removing memory cards.

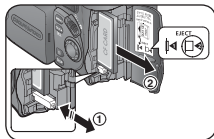



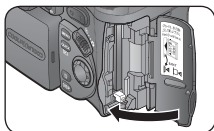

## 4 Close the memory card slot cover

*Format Memory Cards Before First Use*  
Memory cards must be formatted before first use. See “The Shooting Menu: CF Card Format” (p. 104).

## Basic Setup

Follow the steps below to choose a language and set the time and date.

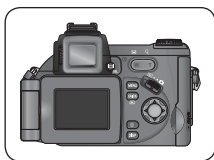

## 1 Ready the monitor

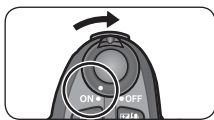
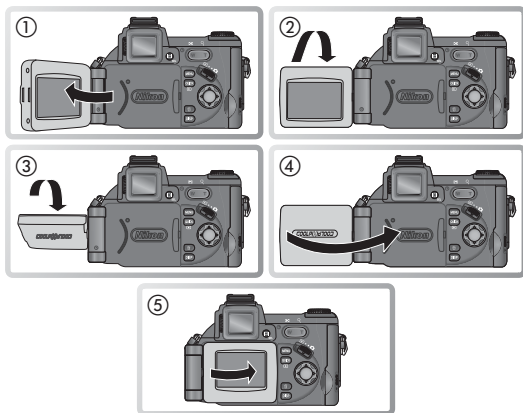

## 2 Turn the camera on

The first time the camera is turned on, a language-selection dialog will be displayed. Choose a language and set the time and date as described on the following pages.

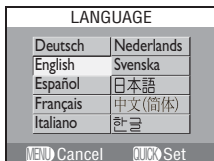

1

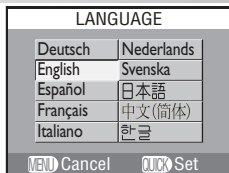

Highlight **Deutsch** (German), **English**, **Español** (Spanish), **Français** (French), **Italiano** (Italian), **Nederlands** (Dutch), **Svenska** (Swedish), **日本語** (Japanese), **中文(简体)** (Simplified Chinese), or **한글** (Korean).\*

\* Press **MENU** button to exit without selecting language. Language-selection dialog will be displayed next time camera is turned on or if monitor is activated after camera has entered standby mode.

2



Confirmation dialog displayed.

3



Highlight **Yes**.†

† Select **No** to exit to mode selected with mode selector. If time and date are not set, Ⓢ ("date not set") icon will flash in monitor during shooting and all pictures will have time stamp of "0000.00.00 00:00." Movies will be dated "2004.01.01 00:00."

4

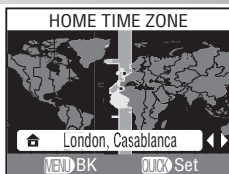

Display map of world time zones.

5

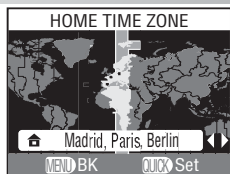

Select home time zone.

## The Clock Battery

When the main battery is installed or an AC adapter is connected, the clock battery will charge in about 10 hours. When fully charged, the clock battery can provide several days of backup power. *The language-selection dialog will automatically be displayed when the clock battery is exhausted.*

## The Camera Clock

The camera clock is less accurate than most watches or household clocks. Check the clock regularly against more accurate timepieces and reset as necessary.

6

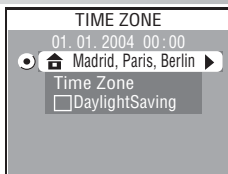

TIME ZONE menu displayed.\*

7

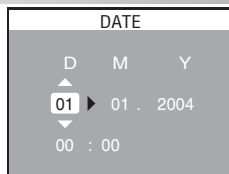

Display DATE menu.

\* If daylight saving time (🌞 125) is in effect in local time zone, highlight **DaylightSaving** and press multi selector right. To return to Step 6, highlight current time zone. To return to Step 4, highlight **Time Zone** and press multi selector right.

8

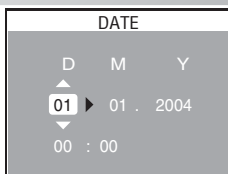

Edit Day (order of Day, Month, and Year may differ in some areas).

9

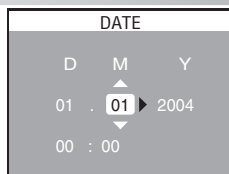

Select Month. Repeat steps 8–9 to edit Month, Year, hour, and minute.

10

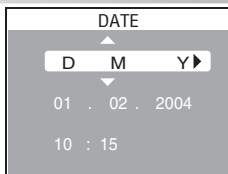

Highlight D M Y.

11

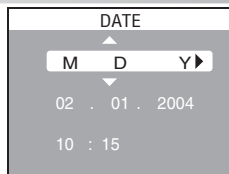

Choose order in which Day, Month, and Year will be displayed.

12



Exit to mode currently selected with mode selector. Note that time and date of recording will not be imprinted on pictures unless **Date** or **Date and time** is selected for **Date imprint** (🌞 136).

# Basic Photography

## Step 1—Select Mode



 (auto) mode is selected automatically the first time the camera is turned on. In this automatic, “point-and-shoot” mode, the majority of settings are controlled by the camera in response to shooting conditions, producing optimal results in most situations.





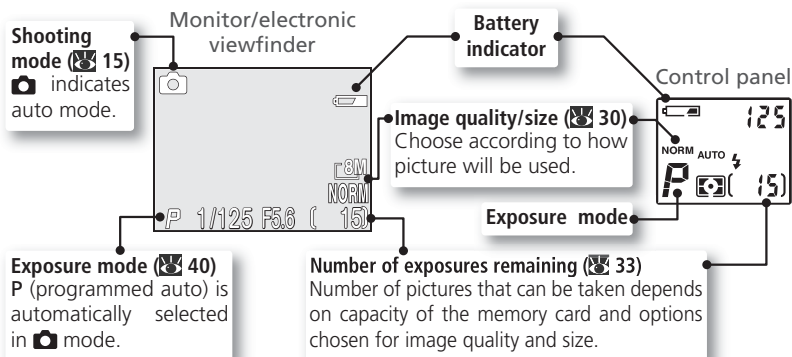

- 1 Slide the mode selector to  and turn the camera on

The lens will extend and the monitor or electronic viewfinder will display a welcome message. The camera is ready to shoot when the message is replaced by the shooting display and settings are displayed in the control panel.



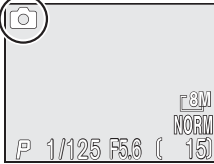

### The Battery Indicator

Monitor	Control panel	Status	Notes
NO ICON		Battery fully charged.	Camera functions normally.
		Low battery. Ready spare battery.	If flash fires, monitor/electronic viewfinder turns off while Speedlight recharges.
WARNING!! BATTERY EXHAUSTED	 (flashes)	Battery exhausted.	No pictures can be taken until battery has been recharged or replaced.



## 2 Confirm that mode is selected

### If Mode Is Not Selected



If  mode is not selected, press the  button and rotate the command dial until the  icon is displayed in the top left corner of the monitor or electronic viewfinder.

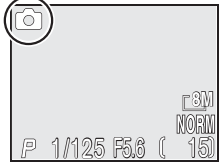

+







\* Icon varies with scene mode selected ( 23).

If **User setting** (the default option) has not been assigned to the  button ( 132), the shooting mode can be selected using camera menus ( 88).



## Shooting Mode

The following shooting modes are available:

Icon	Mode	Description	
	<b>Auto</b>	Automatic, “point-and-shoot” mode.	14–20
Varies	<b>Scene</b>	Automatic mode with choice of twelve “scenes” suited to different subjects or shooting conditions.	23–29
	<b>Custom 1</b>	Manual modes that offer control over all settings.	88
	<b>Custom 2</b>	Separate adjustments can be made in each mode.	

## Number of Exposures Remaining

If the number of exposures remaining reaches zero, the message “OUT OF MEMORY” will be displayed in the monitor. No further pictures can be taken until:

- a new memory card is inserted ( 10)
- pictures are deleted ( 21, 106)

The “OUT OF MEMORY” message may clear from the display if a lower image quality or size is selected ( 30).

## Step 2—Frame the Picture

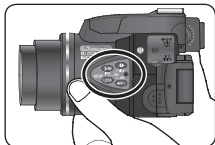

Avoid pressing buttons on left side of camera while shooting.

### 1 Ready the camera

Hold the camera steadily in both hands.

#### Don't Block the Shot

To avoid muffled sound or dark or partially obscured pictures, keep fingers and other objects away from the microphone, lens, and flash.

To avoid blocking the red-eye reduction lamp, keep your fingers below the ridges on the camera grip.

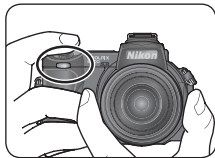

Zoom out      Zoom in

### 2 Frame the subject

The camera is equipped with two types of built-in zoom: optical zoom, in which the camera's tele-scoping lens can be used to magnify the subject up to 8 $\times$ , and digital zoom, in which digital processing is used to further magnify the image up to 4 $\times$ , for a total of 32 $\times$ . Use the zoom buttons to frame your subject in the center of the monitor:

- Press the **W** button to zoom out from your subject, increasing the area visible in the frame.
- Press the **T** button to zoom in on your subject so that it fills a larger area of the frame.
- When the camera is zoomed in to maximum magnification, holding the **T** button down for about two seconds will trigger digital zoom, and the zoom indicator will turn yellow. Use the **T** and **W** buttons to adjust zoom in the digital zoom range. To cancel digital zoom, press **W** until the zoom indicator turns white.

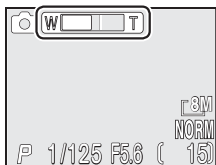

Indicator shows amount of zoom when either button is pressed

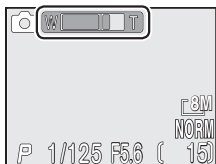

Digital zoom

### **The Built-in Speedlight**

At default settings, the built-in Speedlight will pop up automatically when the shutter-release button is pressed halfway if additional light is required for correct exposure. Do not place your fingers where they will obstruct the built-in Speedlight. If the Speedlight is prevented from popping up when the shutter-release button is pressed halfway, a message will be displayed.



Do not attempt to raise the Speedlight by hand. Failure to observe this precaution could result in damage to the Speedlight. To lower the Speedlight, gently press it straight down until it clicks into place. Do not apply force to the front, back, or sides.

### **Digital Zoom (Z 95)**

In digital zoom, data from the camera's image sensor are processed digitally, enlarging the center portion of the picture to fill the frame. Unlike optical zoom, digital zoom does not increase the amount of detail visible in the picture. Instead, details visible at maximum optical zoom are simply enlarged, producing a slightly "grainy" image.

### **When Lighting Is Poor**



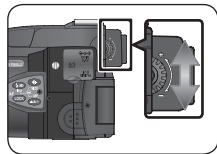

When lighting is poor, sensitivity is raised to compensate and the image in the monitor may be slightly mottled. This is normal and does not indicate a malfunction.

### **Viewfinder Focus**

If the image in the electronic viewfinder seems blurred, rotate the diopter adjustment control until the image is in sharp focus. When operating the diopter control with your eye to the viewfinder, care should be taken to avoid accidentally putting your finger in your eye.



### **Auto Power Off (Standby Mode)**

If no operations are performed for one minute (three minutes when menus are displayed), the monitor and electronic viewfinder will turn off automatically and the camera will enter standby mode, reducing the drain on the batteries (if the camera is powered by an optional AC adapter or the **Loop** option is selected during a slide show  112], the monitor and viewfinder will turn off after thirty minutes). To reactivate the display, press the    or  button or press the shutter-release button halfway.

The length of time before the camera enters standby mode can be changed using the **Auto off** option in the setup menu  131).

## Step 3—Focus and Shoot

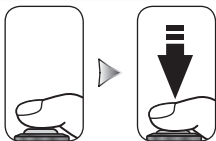

### 1 Focus

Press the shutter-release button halfway to set focus and exposure (7). In camera mode, the camera will automatically focus on the subject at the center of the frame. Focus and exposure will lock while the shutter-release button is pressed halfway. If the subject is poorly lit and the flash is on, the built-in Speedlight will pop up automatically and begin charging.

Flash indicator

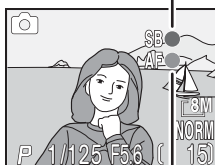

Focus indicator

With the shutter-release button pressed halfway, check the focus and flash indicators in the monitor or electronic viewfinder.

Flash indicator	On (red)	Flash will fire when picture is taken.
	Blinks red	Flash charging.
	Off	Flash off or not required.
Focus indicator	On (green)	Subject in focus.*
	Blinks green	Camera unable to focus on subject at center of frame. Using focus lock, focus on another subject at same distance, then recompose picture and shoot.

\* Always lights when focus is set to infinity (37) or manual focus is used (47).



### 2 Take the picture





Press the shutter release button the rest of the way down to take the picture. To prevent blur, press the shutter-release button down smoothly.

#### Display Lag

The image from the camera CCD must be processed before it can be displayed in the monitor or electronic viewfinder, resulting in a slight lag between the movement of the subject and the image in the display. This lag can be reduced by selecting **Quick response** for the **Monitor options > Shutter release speed** option in the setup menu (126).



## ✓ During Recording

While pictures are being recorded to the memory card, a  (recording) or  (wait) icon will be displayed in the monitor or electronic viewfinder. The camera can continue to take pictures until the  icon is displayed. *Do not turn the camera off, eject the memory card, or remove or disconnect the power source while the  or  icon is displayed.* Cutting power or removing the memory card in these circumstances could result in loss of data or in damage to the camera or card.









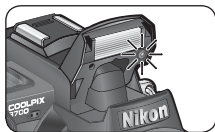



## ✎ Low Battery

If the flash fires when the low battery icon is displayed, the monitor will turn off while the Speedlight recharges.

## 🔦 The AF-Assist Illuminator

If lighting is poor when the shutter-release button is pressed halfway, the built-in Speedlight will pop up and the AF-assist illuminator will light, allowing the camera to focus even when the subject is poorly lit. The AF-assist illuminator has a range of about 1.2m (3'11"). The AF-assist illuminator will not light if:



- The built-in Speedlight is obstructed, preventing it from popping up (note that the AF-assist illuminator may light even when the flash is off; be careful not to obstruct the Speedlight while shooting)
- Focus mode  37 is set to  (infinity)
-  (Portrait),  (Night Portrait), or  (Close up) or is selected in scene mode  24–26 or **Manual** is chosen for **Focus options > AF area mode**  93) and the center focus area is not selected
-  (Landscape),  (Night landscape), or  (Fireworks show) is selected in scene mode  25–26)
- A setting other than **Time-lapse movie** is selected in movie mode  49)
- **Manual** is selected for **Speedlight opt. > Pop up**  96) and the built-in Speedlight is lowered

## 🔦 Getting Good Results with Autofocus

Autofocus performs best when there is contrast between the subject and the background and the subject is evenly lit. It does not perform well if the subject is very dark or moving rapidly, if there are objects of sharply differing brightness in the scene (e.g., the sun is behind your subject and their features are in deep shadow), or if there are several objects at different distances from the camera at the center of the frame (e.g., your subject is inside a cage).

## AF/AE Lock

Focus and exposure are locked when the shutter-release button is pressed halfway, and remain locked while the shutter-release button is held in this position (focus lock). Focus lock can be used to take pictures of off-center subjects or in situations in which the camera is unable to focus using autofocus.

### 1 Focus



Position subject in center of frame and press shutter-release button halfway.

### 2 Check focus indicator

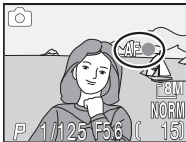

Check that focus indicator glows steadily, indicating that subject is in focus.

### 3 Recompose picture

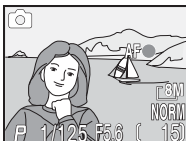

Focus and exposure are locked while shutter-release button is pressed halfway.\*

### 4 Take picture



Press shutter-release button rest of way down to take picture.

\* Do not change distance between camera and subject while focus lock is in effect. If subject moves, release shutter-release button and focus again at new distance.

## The LOCK Button

Focus and exposure will also lock while the **LOCK** button is pressed (if desired, the **LOCK** button can be used to lock focus but not exposure, or vice versa; 132).



## Step 4—View the Results (Quick Review/Full-Screen Review)

The **QUICK** button can be used to view pictures without leaving shooting mode.

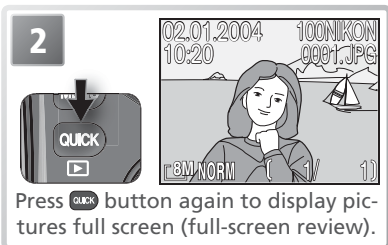
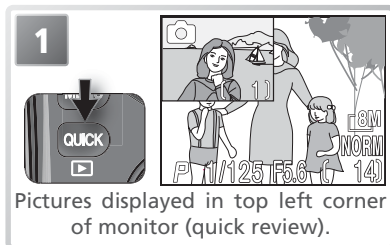

Use the multi selector to view additional pictures. Press the multi selector down or right to view pictures in the order recorded, up or left to view pictures in reverse order. To return to shooting mode, press the **QUICK** button a third time or press the shutter-release button halfway.

### Deleting Unwanted Pictures (Full-Screen Review)

To delete the picture displayed in full-screen review, press the **DISP** button. A confirmation dialog will be displayed; press the multi selector up or down to highlight an option and then press the multi selector to the right to make a selection.

- **Yes:** Delete the picture and return to full-screen review
- **No:** Exit to full-screen review without deleting the picture

#### Quick Review

Pressing the **DISP** button will not delete pictures displayed in quick review.



### Playback Mode

Pictures can also be viewed by sliding the mode selector to **▶** (playback mode; **55**).

### Playback Tips





Pictures are displayed briefly at low resolution while being read from the memory card. This makes it possible to scroll rapidly through the pictures in memory without waiting for each image to be displayed at full resolution.

## Image File and Folder Names

On the memory card, pictures are identified by file names with three parts: a four letter identifier, a four-digit file number assigned automatically by the camera in ascending order, and a three-letter extension (e.g., "DSCN0001.JPG").

	Type	Identifier	Extension	
Original	RAW-quality still	DSCN	.NEF	30
	HI-quality still	DSCN	.TIF	30
	FINE-, NORMAL-, or BASIC-quality still	DSCN	.JPG	30
	Movie	DSCN	.MOV	49
	Time-lapse movie	INTN	.MOV	49
Copy	Cropped copy	RSCN	.JPG	60
	Small copy	SSCN	.JPG	62
Audio file	Voice memo (appended to original still)	DSCN	.WAV	63
	Voice memo (appended to cropped copy)	RSCN	.WAV	63
	Voice memo (appended to small copy)	SSCN	.WAV	63

When a picture is viewed on the camera, the file number and extension appear in the top right corner of the display. The identifier is not displayed, but is visible when the picture is transferred to a computer.

Pictures are stored in folders named with a three-digit folder number followed by a five-character identifier (e.g., "100NIKON"). The default identifier is NIKON; if desired, folders with other identifiers can be created and pictures organized by theme ( 108). Each sequence of pictures taken using interval-timer photography, **Ultra HS**, or panorama assist is stored in a separate folder with its own identifier: "INTVL" for interval timer photography ( 83), "N\_" plus a three-digit sequence number for **Ultra HS** (e.g., "101N\_001";  80), or "P\_" plus a three-digit sequence number for panorama assist (e.g., "101P\_001";  29). Folders can hold up to 200 pictures; if a picture is taken when the current folder contains 200 pictures, a new folder will be created by adding one to the current folder number. If a picture is taken when the current folder contains a picture numbered 9999, a new folder will be created and file numbering will begin again from 0001. If the current folder is numbered 999 and contains 200 pictures or a picture numbered 9999, no further pictures can be taken until the memory card is formatted ( 104) or a new memory card inserted.

The first picture displayed when pictures are played back is the picture with the highest file number in the highest-numbered folder.

# Scene Mode

## Taking Pictures in Scene Mode

Scene mode offers a menu of twelve “scenes,” each corresponding to a common situation, such as a backlit subject, sunset, or interior shot. Camera settings are automatically adjusted to suit the selected scene, sparing the user the necessity of adjusting each setting separately. To select a scene:

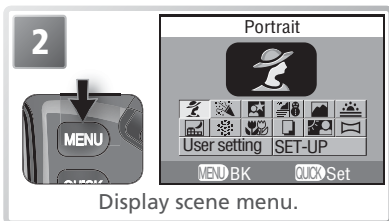
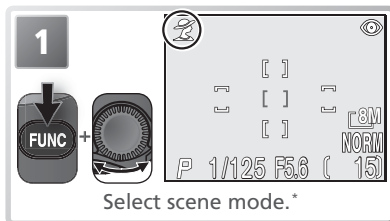

\* Default scene is . If **User setting** has not been assigned to **FUNC** button ( 132), scene mode can be selected using camera menus ( 88).

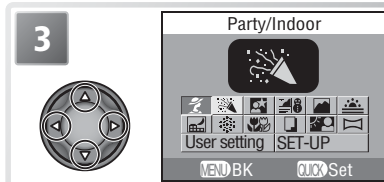

Highlight scene (scene can also be highlighted by rotating command dial). Highlighted scene shown by large icon and caption. To exit without changing current selection, press **MENU**.

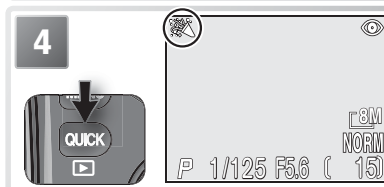

Select highlighted scene and return to shooting mode. Selected scene shown by icon in monitor or electronic viewfinder.

### The Scene Menu

The scene menu also contains a **User setting** option for choosing the shooting mode ( 88) and a **SET-UP** option for access to the camera setup menu ( 122).

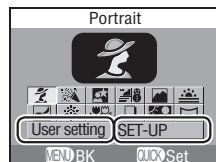



Depending on the scene selected, restrictions may apply to flash mode (⚡️; 34), the AF-assist illuminator (☀️; 19), focus mode (▲👤👤; 37), or focus area selection (👤; 93). These restrictions are noted on the pages that follow.

### 👤 Portrait (SC E 1)

Use for portraits. Main subject stands out clearly while background details are softened, lending composition sense of depth.

- Degree of softening depends on amount of light available.



### 👤 Party/Indoor (SC E 2)

Use for shots that include details of the background, or to capture the effects of candlelight and other indoor background lighting.

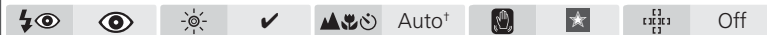
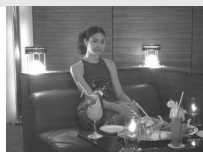

\* Other modes can be selected.

† Self-timer can be used.

## ✍️ Scene Mode

Depending on your subject, scene mode may not always produce the desired results. If results are not satisfactory, choose 📷 (auto) mode and try again.

### ✍️ The AF-Assist Illuminator

In 👤 (Portrait), 📷 (Night Portrait), and 👤👤 (Close up) modes, the AF-assist illuminator is only available when the center focus area is selected.

### 📷 Camera Shake (📷)

In some scenes, slow shutter speeds may result in blurred pictures. The number of stars next to the 📷 icon indicates the precautions appropriate for avoiding blur:

- ★ hold camera in both hands and brace elbows against body
- ★★ use tripod or rest camera on flat, level surface

### 📷 Selecting a Scene

The scene can also be selected by pressing the **MODE** button and rotating the command dial. Selected scene is shown in control panel as SC E 1-SC E c.

** Night portrait (SC E3)**

Use for shots that provide natural balance between main subject and background when shooting portraits under low light.

- Noise reduction ( 101) turns on automatically at slow shutter speeds.

** Beach/Snow (SC E4)**

Captures the brightness of such subjects as snowfields, beaches, or sunlit expanses of water.

** Landscape (SC E5)**

Use for vivid landscape shots that enhance outlines, colors, and contrast in such subjects as skyscapes and forests.

- Camera focuses at infinity. Focus indicator lights whenever shutter-release button is pressed halfway.

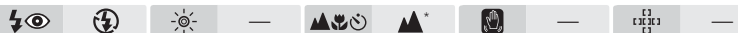
** Sunset (SC E6)**

Preserves the deep hues seen in sunsets and sunrises.



\* Self-timer can be used.

† Other modes can be selected.

**Night landscape (S C E 7)**

A slow shutter speed is used to produce stunning night landscapes.

- Noise reduction (👁️ 101) turns on automatically at slow shutter speeds.
- Focus is fixed at infinity. Focus indicator lights whenever shutter-release button is pressed halfway.

**Fireworks show (S C E 8)**

Slow shutter speeds are used to capture the expanding burst of light from a firework.

- Focus is fixed at infinity. Focus indicator lights whenever shutter-release button is pressed halfway.
- Self-timer and exposure compensation can not be used.

**Close up (S C E 9)**

Use for close-up shots of flowers, insects, and other small objects.

- Camera focuses continuously until shutter-release button is pressed halfway to lock focus. Minimum focus distance varies with zoom position. To focus on objects as close as 3 cm/1.2" to lens, adjust zoom until macro close-up icon (🌸) turns green. (Note that flash may not light entire subject at ranges of 50 cm/1'8" or less. Take test shot and examine results in monitor or electronic viewfinder.)

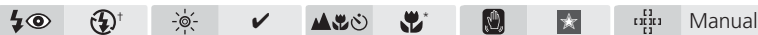

\* Self-timer can be used.

† Other modes can be selected.



 **Copy (S E E)**

Provides clear pictures of text or drawings on a white board or in printed matter such as a business card.

- Use macro close-up ( 37) to focus at short ranges.
- Colored text and drawings may not show up well in final picture.

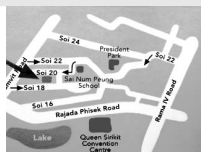
 **Back light (S E E)**

Use when light is coming from behind a portrait subject, throwing their features into shadow, or when the subject is in the shade but the background is brightly lit. The flash will fire automatically to “fill in” (illuminate) shadows.

 **Panorama assist (S E E; 28)**

Use when taking a series of pictures that will later be joined to form a single scene (for example, a panorama or 360° virtual-reality image).



- White balance and exposure are fixed at values for first shot in series. Exposure compensation, flash mode, focus mode, and zoom can not be changed after first shot.





\* Other modes can be selected.

† Macro close-up and self-timer can be selected.

‡ Self-timer can be used.

 **Noise Reduction**

“Noise” in the form of randomly-spaced, brightly-colored pixels tends to appear in pictures taken at slow shutter speeds. This effect is particularly noticeable in dark areas of the picture. In  (night portrait) and  (night landscape) modes, pictures taken at slow shutter speeds are processed to reduce noise (this more than doubles the time needed to process pictures before they are saved to the memory card). **NR** is displayed in these modes.

## Taking Pictures for a Panorama

- 1** Select  (Panorama assist) in scene menu as described in steps 1–3 of “Taking Pictures in Scene Mode” (p. 23).

**2**

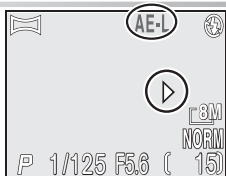

Default pan direction displayed.

**3**

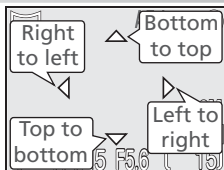

Select how pictures will be joined together in completed panorama. This is the direction in which to pan the camera after each shot. Yellow AE-L icon in monitor shows that white balance and exposure will lock with first shot.

**4**



Take first picture. About one third of picture is shown superimposed on view through lens (if pan direction is left to right, picture will appear on left side of monitor). AE-L icon turns white to show that white balance and exposure settings for this picture apply to all pictures in series.

**5**



Compose next shot to overlap with previous picture.

**6**



Take next shot. Repeat steps 5-6 until all shots in series have been taken.

**7**



End series.

 **Panorama Assist**

Pan direction, zoom, exposure compensation, image quality and size, flash mode, and focus mode can not be changed after the first picture is taken. Pictures can not be deleted until shooting is complete.

 **Viewing Pictures Taken Using Panorama Assist**

Each series of pictures taken at **Panorama assist** is stored in a separate folder with a name consisting of "P\_" preceded by a three-digit folder number and followed by a three-digit sequence number (e.g., "101P\_001"). To view the pictures, select **All folders** in the playback **Folders** menu or select the appropriate folder from the folder list ( 111).

 **Use a Tripod**

Using a tripod makes it easier to compose overlapping shots.



# More on Photography

## Image Quality and Size

More on Photography



Pictures taken with a digital camera are stored as image files. The size of the files, and with it the number of images that can be recorded on the memory card, depends on the quality and size of the images. Before shooting, choose image quality and size according to how the picture will be used.

### Image Quality

The camera stores images in one of three formats: NEF (RAW), TIFF (HI quality), or JPEG (FINE, NORMAL, or BASIC quality).

Option	Format	Compression ratio <sup>1</sup>	Description
RAW <sup>2, 3</sup>	NEF	Not compressed	Raw data from CCD are saved in Nikon Electronic Image Format (NEF) without processing or compression, preserving high level of detail at file size slightly smaller than that of TIFF images.
HI <sup>2, 4</sup>	TIFF		High image quality (on par with NEF) in format supported by most imaging applications.
FINE	JPEG	1:4	Fine image quality, suitable for enlargements or high-quality prints.
NORM (NORMAL)		1:8	Normal image quality, suited to most applications.
BASIC		1:16	Basic image quality, suitable for pictures that will be distributed by e-mail or used in web pages.

1 To reduce the amount of memory each shot occupies, JPEG images are compressed as they are saved to the memory card. Compression selectively reduces the quality of the image; the more a picture is compressed, the more noticeable this loss of quality is likely to be. This column gives the approximate compression ratio for each setting.

2 Available only in shooting modes **1** (Custom 1) and **2** (Custom 2). Selecting  (auto) or scene mode resets image quality to FINE. Digital zoom ( 16) not supported.

3 Available only at an image size of **8M**. Direct print ( 69) not supported.

4 Available only at image sizes of **8M** and **3:2**.

To choose an image quality setting:

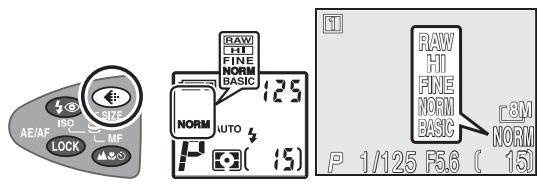

Press button until desired setting appears in control panel and shooting display.

### Viewing RAW (NEF) Images on a Computer

RAW (NEF) images can only be viewed using PictureProject or Nikon Capture (versions 4.0 or earlier excluded; for more information, see the web sites listed on page 1 of this manual). To create a TIFF copy for viewing in other applications, press the button while a RAW image is displayed in full-frame playback ( 56). The copy will be saved under a name with the extension .TIF.

## Image Size

Image size refers to the dimensions of the image, measured in pixels. Pictures taken at smaller sizes require less memory, making them suited to distribution by e-mail or the web. Conversely, the larger the image, the larger the size at which it can be printed or displayed without becoming noticeably “grainy.”

Image size (pixels)	Control panel	Description (print sizes assume printer resolution of 300 dpi)
<b>8M</b> (3,264 × 2,448)	- 8 -	Will print at a size of about 28 × 21 cm (11" × 8").
<b>5M</b> (2,592 × 1,944)	- 5 -	Will print at a size of about 22 × 16 cm (8½" × 6½").
<b>3M</b> (2,048 × 1,536)	- 3 -	Will print at a size of about 17 × 13 cm (7" × 5").
<b>2M</b> (1,600 × 1,200)	- 2 -	Will print at a size of about 14 × 10 cm (5½" × 4").
<b>1M</b> (1,280 × 960)	- 1 -	Will print at a size of about 11 × 8 cm (4" × 3").
<b>PC</b> (1,024 × 768)	PC	Suited to printing at smaller sizes (for example, as illustration in letter or report) or to display on monitors 17" or larger.
<b>TV</b> (640 × 480)	TV	Can be displayed full screen on 13" monitors. Suited to distribution by e-mail or on web.
<b>3:2</b> (3,264 × 2,176)	3:2	Top and bottom of frame cropped out to produce picture of same proportions as frame of regular 35-mm film.

To choose an image size:

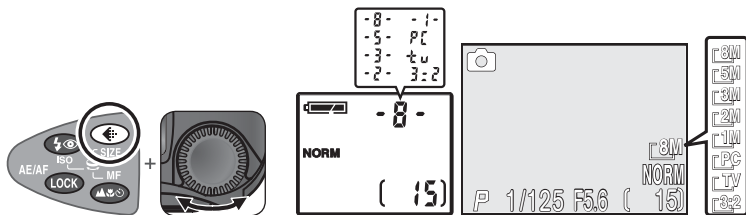

Press **SIZE** button and rotate command dial until desired setting appears in control panel and shooting display.

## Print Size

The size of images when printed depends on the printer resolution: the higher the resolution, the smaller the final print size.

## Memory Card Capacity and Image Quality/Size

The following table shows the approximate number of pictures that can be stored on a 256MB memory card at different combinations of image quality and size.

Image size	Image quality					
	RAW	HI	FINE	NORMAL	BASIC	
8M	20	10	64	126	244	No. of images
	12 MB	23 MB	4 MB	2 MB	1 MB	File size
5M	—	—	100	195	373	No. of images
	—	—	3 MB	2 MB	650 KB	File size
3M	—	—	159	313	602	No. of images
	—	—	2 MB	800 KB	420 KB	File size
2M	—	—	252	489	870	No. of images
	—	—	960 KB	500 KB	270 KB	File size
1M	—	—	391	712	1306	No. of images
	—	—	630 KB	330 KB	190 KB	File size
PC	—	—	602	979	1567	No. of images
	—	—	420 KB	230 KB	130 KB	File size
TV	—	—	1306	1959	2612	No. of images
	—	—	190 KB	110 KB	80 KB	File size
3:2	—	11	71	142	279	No. of images
	—	21 MB	4 MB	2 MB	900 KB	File size

\* All figures are approximate. File size of JPEG images varies with scene recorded.



## Flash Mode

Select a flash mode according to lighting conditions.

Mode		How it works	When to use it
Shooting display	Control panel		
NO ICON Auto	AUTO	When lighting is poor, built-in Speedlight pops up when shutter-release button is pressed halfway and fires when picture is taken. If left raised, flash will not fire if not required.	Recommended for most situations.
	Flash Cancel (off)	Flash will not fire even when lighting is poor.	Use to capture natural lighting under dim light or where use of flash is prohibited. Care should be taken to avoid blurring when lighting is poor.
	Auto with red-eye reduction	Red-eye reduction lamp lights before main flash fires, reducing "red-eye."	Use for portraits (works best if subject looks directly at red-reduction lamp). Not recommended when quick shutter response is required.
	Anytime Flash (fill flash)	Flash fires whenever picture is taken.	Use to "fill-in" (illuminate) shadows and back-lit subjects.
	AUTO Slow sync	Auto flash combined with slow shutter speeds.	Use to capture both subject and background at night or under dim light. Care should be taken to avoid blurring when lighting is poor.

### Auto Flash Off

The built-in Speedlight turns off automatically when focus is set to infinity ( 37), an option other than **Single** is selected for **Continuous** ( 80), BSS ( 84) is on, a setting other than **Normal** is selected for **Lens** ( 90), **AE lock** ( 91) is on, or **Internal off** is selected for **Speedlight opt. > Speedlight cntrl** ( 97).

### Sensitivity (ISO Equivalency; 46)

A sensitivity of 400 is not recommended when using a flash.

### Speedlight Options ( 96)

The **Speedlight opt.** item in the shooting menu contains options controlling the built-in and optional Speedlights.



To choose a flash mode:

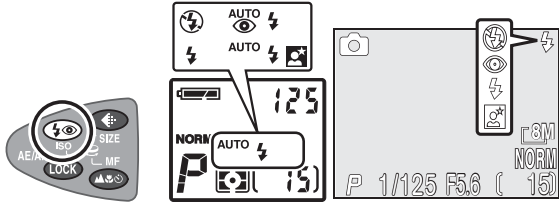

Press button until desired setting appears in control panel and shooting display (note that no icon appears in shooting display when flash is set to auto).

Flash mode changes as follows:

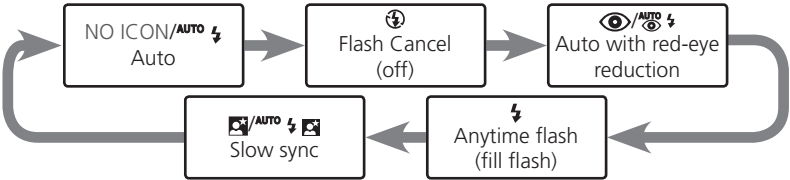

**Manual Pop-Up**

When **Manual** is selected for **Speedlight opt.** > **Pop up**, the built-in Speedlight can be raised by pressing the button. When raised, the flash will fire whenever the shutter is released. The flash mode can not be changed while the Speedlight is lowered; when the Speedlight is raised, the following flash modes are available:

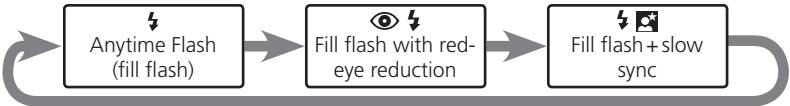

**Flash Range**

Flash range varies with zoom position. When the camera is zoomed all the way out, the flash has a range of 0.5–4.1m/1'8"–13'5". The range at maximum zoom is 0.5–2.7m/1'8"–8'10" (Auto ISO). At ranges of 0.5m (1'8") or less, the flash may not light the entire subject. When using the flash at short range, play pictures back after shooting to check the results.

**Low Battery**

If the built-in Speedlight fires while the (low battery) icon is displayed, the monitor will turn off while the flash recharges.

## ✓ Using the Built-in Speedlight

Do not attempt to raise the Speedlight by hand. When lowering the Speedlight, gently press straight down until it clicks into place, being careful not to pinch your fingers, hair, or other objects. Do not apply force to the front, back, or sides of the Speedlight. Failure to observe these precautions could damage the Speedlight.

## ✎ Do Not Obstruct the Built-in Speedlight

When **Auto** (the default option) is selected for **Speedlight opt.** > **Pop up**, the built-in Speedlight will pop-up automatically when required (because the photocell used for flash control is part of the built-in flash unit, the Speedlight will pop up automatically even when an optional flash is mounted on the camera accessory shoe). Do not place your fingers or other objects on top of the Speedlight while shooting. If the Speedlight is held down when the shutter-release button is pressed halfway, a message will be displayed. Pictures can still be taken, but neither the built-in Speedlight nor optional Speedlights will fire. Note that the built-in Speedlight will pop up even when off (🔇) if the AF-assist illuminator is required.

## ✎ Lens Hoods

Remove lens hoods (available separately; 📷 137) when using the flash.

## ✎ When Lighting Is Poor

When lighting is poor and the flash is off (🔇) or set to slow sync (📷), shutter speed slows and pictures may be blurred. At speeds slower than  $\frac{1}{4}$  s, the shutter-speed indicator in the monitor or electronic viewfinder will turn yellow to indicate that dark areas of the image may be slightly mottled. Mottling can be reduced by turning noise reduction on (📷 101). At speeds slower than  $\frac{1}{30}$  s, we recommend using a tripod or resting the camera on a steady, level surface.

If 📷 (auto) or scene modes, or when sensitivity (📷 46) is set to AUTO in shooting modes 1 and 2, the camera will automatically increase sensitivity to a maximum of ISO 200 in response to lighting conditions, permitting faster exposures and minimizing blur caused by inadvertent camera movement (camera shake). An ISO icon will be displayed to warn that pictures may be slightly mottled.

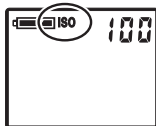
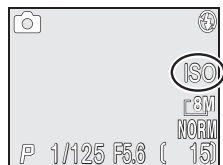





## 📷 Optional Speedlights

Optional Speedlights can be mounted on the camera's accessory shoe (📷 96).





## Focus Mode

Choose a focus mode according to the subject and composition.

Mode	How it works	When to use it
NO ICON Autofocus	Camera automatically adjusts focus according to distance to subject.	Use when subject is 50 cm (1'8") or more from lens.
 Infinity	Camera focuses at infinity; focus indicator lights whenever shutter-release button is pressed halfway. Flash is disabled.	Use when shooting distant scenes through foreground objects such as windows.
 Macro close-up	If zoomed in or out until  icon in the shooting display turns green, camera can focus on objects as close as 3 cm (1.2") to lens.	Use for close-ups.
 Self-timer	Combines autofocus (see above) at distances of 3 cm (1") or more with shutter-release delay of 10s or 3s.	Use for self-portraits or to prevent pictures from blurring when shutter-release button is pressed.

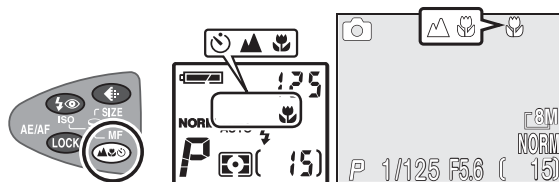
To choose a focus mode:



Press  button until desired setting appears in control panel and shooting display.

Focus mode changes as follows:

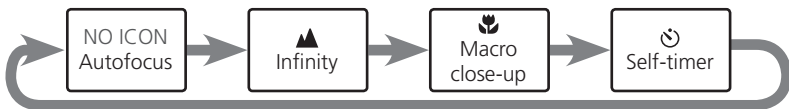

## Manual Focus

For information on manual focus, see "Manual Focus" ( 47).



## Self-Timer Mode

The self-timer can be used for self-portraits or to avoid blurring that may result from the camera moving when the shutter-release button is pressed.

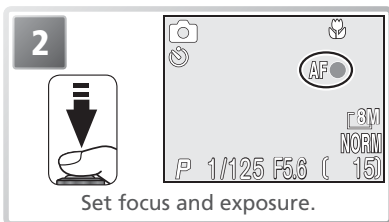
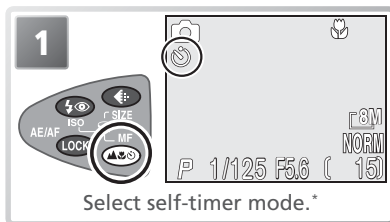

\* icon is displayed; camera focuses in macro close-up mode ( 37).

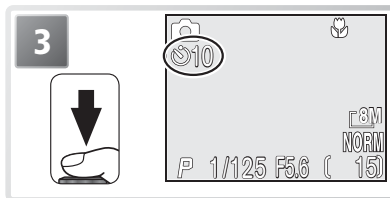

Start timer. Press once for delay of about 10s, twice for delay of about 3s. Beep sounds when timer starts; timer in shooting display counts down until shutter is released. To stop timer before picture is taken, press shutter button twice (10s timer) or once (3s timer).

The self-timer lamp on the front of the camera will blink until one second before the picture is taken, staying lit during the final second to warn that the shutter is about to be released.

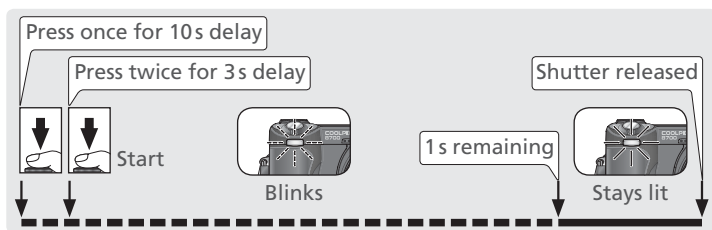

### The Self-Timer

The **Continuous** option in the shooting menu is automatically set to **Single** when self-timer mode is selected ( 80). The self-timer is not available when (Fireworks show) is selected in scene mode ( 26).

When using manual focus ( 47), select the self-timer before choosing a focus distance. Choosing another focus mode automatically cancels manual focus.

## Exposure Compensation

Exposure compensation is used to alter exposure from the value suggested by the camera. Exposure compensation can be set to values between  $-2.0$  EV (underexposure) and  $+2.0$  EV (overexposure) in increments of  $\frac{1}{3}$  EV.

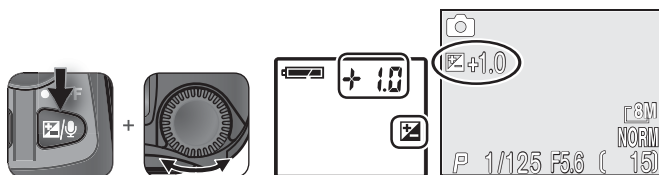

Press  button and rotate command dial until desired setting appears in control panel and shooting display.

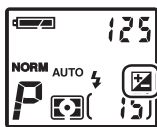

At settings other than 0.0,  icon is displayed in control panel after  button is released.

### Restrictions on Exposure Compensation

Exposure compensation is not available in manual exposure mode ( 44) or when  (Fireworks show) is selected in scene mode ( 26).

### Cancelling Exposure Compensation

To cancel exposure compensation, choose a value of 0.0. In  (auto) and scene modes, exposure compensation will be reset to 0.0 when the camera is turned off or another shooting mode is selected.

### Choosing a Value for Exposure Compensation

As a rule of thumb, select *positive* values when large areas of the frame are very brightly lit (for example, when photographing an expanse of sunlit water, sand, or snow) or when the background is much brighter than the main subject. Choose *negative* values when large areas of the frame are very dark (for example, when photographing a forest of dark green leaves) or when the background is much darker than the main subject. This is because the camera, in order to avoid extreme under- or over-exposure, tends to lower exposure when the frame is very bright and raise exposure when the frame is very dark, which can make naturally bright subjects look dim and naturally dark subjects appear over-bright, or “washed out.”

## Exposure Mode (Shooting Modes 1 and 2 Only)

In (auto) and scene modes, the camera automatically adjusts shutter speed and aperture to produce optimal exposure. In shooting modes 1 (Custom 1) and 2 (Custom 2), a choice of four exposure modes gives the user direct control over shutter speed and aperture.

Mode	How it works	When to use it
<b>P</b> Programmed auto	Camera sets shutter speed and aperture for optimal exposure. Flexible program can be used to select additional combinations of shutter speed and aperture that will produce the same exposure.	Recommended for most situations.
<b>S</b> Shutter-priority auto	User chooses shutter speed; camera sets aperture for best results.	High shutter speeds freeze motion. Low shutter speeds suggest movement by blurring moving objects.
<b>A</b> Aperture-priority auto	User chooses aperture; camera sets shutter speed for best results.	Large apertures (small f-numbers) soften background details and let more light into camera, increasing range of flash. Small apertures (large f-numbers) increase depth of field, bringing main subject and background into focus.
<b>M</b> Manual	User controls both shutter speed and aperture.	Use for complete control over exposure.

To choose the exposure mode:

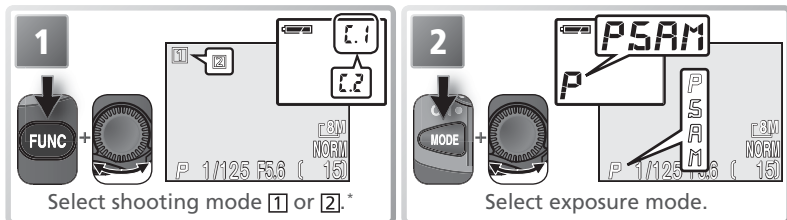

\* If **User setting** has not been assigned to button (132), shooting mode can be selected in shooting menu (88).

## P: Programmed Auto

In programmed auto, the camera automatically adjusts shutter speed and aperture according to the amount of light available, producing optimal exposure in most situations. Adjustments to exposure can be made using exposure compensation (📷 39) or exposure bracketing (📷 99).

## Flexible Program

In programmed auto, different combinations of shutter speed and aperture can be selected by rotating the command dial (flexible program). Each combination of shutter speed and aperture will produce the same exposure.

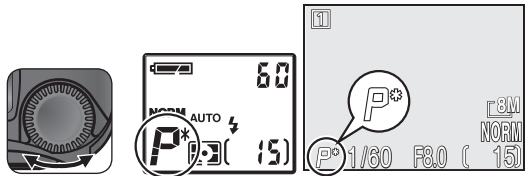

Shutter speed and aperture shown in shooting display. Asterisk ("\*") appears when flexible program is in effect. Control panel shutter speed/aperture display shows either shutter speed or aperture; press **MODE** button to switch from one to the other.

## 🔍 Restoring Default Values for Shutter Speed and Aperture

Default values for shutter speed and aperture can be restored by rotating the command dial until the asterisk ("\*") is no longer displayed. Default values can also be restored by selecting another exposure mode or turning the camera off.

## ⦿ S: Shutter-Priority Auto

In shutter-priority auto, the user selects the shutter speed by rotating the command dial; aperture is set automatically by the camera in response to lighting conditions. Shutter speed can be set to values between 8 s and  $\frac{1}{4,000}$  s in increments equivalent to 1 EV (one step).

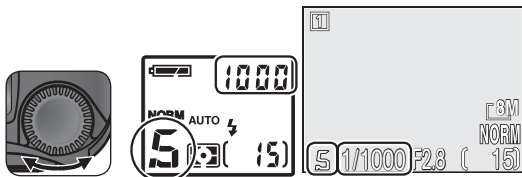

Rotate command dial until desired shutter speed appears in control panel and shooting display.

If the selected shutter speed would result in the picture being under- or over-exposed, the shutter-speed display in the monitor or electronic viewfinder will flash when the shutter-release button is pressed halfway. Choose another shutter speed and try again. At speeds slower than  $\frac{1}{4}$  s, the shutter-speed indicator in the shooting display will turn yellow to show that mottling may appear in the final picture. If possible, choose a faster shutter speed or use noise reduction (101).

### ✍ Ultra HS

When **Ultra HS** is selected for **Continuous** (80), the frame advance rate is fixed at thirty frames per second, with the result that the shutter speed can not be set to a value slower than  $\frac{1}{30}$  s.

### ✍ Aperture Restrictions

At a shutter speed of  $\frac{1}{4,000}$  s, aperture is restricted to f/7.4 (maximum zoom) or to values between f/5.0 and f/8.0 (camera zoomed out to widest angle).



## A: Aperture-Priority Auto

In aperture-priority auto, aperture is controlled by rotating the command dial; shutter speed is set automatically by the camera in response to lighting conditions. Aperture varies in increments equivalent to  $\frac{1}{3}$  EV ( $\frac{1}{3}$  step); depending on the zoom position, the camera can achieve apertures as large as f/2.8 or as small as f/8.

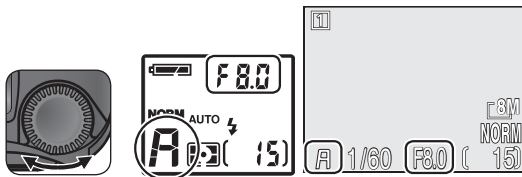

Rotate command dial until desired aperture appears in control panel and shooting display.

If the selected aperture would result in the picture being under- or over-exposed, the aperture display in the monitor or electronic viewfinder will flash when the shutter-release button is pressed halfway. Choose another aperture and try again.

An aperture of f/8 may not be available at some zoom positions. For smaller apertures, try zooming the camera out.

### Aperture and Zoom

The maximum and minimum values for aperture are determined by the camera lens and zoom setting. Unless **On** is chosen for **Zoom options > Fixed aperture** ( 95), aperture will change as the camera is zoomed in or out. If the second-highest aperture setting is selected with the camera zoomed all the way out and the camera is then zoomed in, the camera will vary the f-number to maintain aperture at the second-highest setting for the current zoom position.

### Faster Shutter Speeds

Depending on the amount of light available, it may be possible to achieve shutter speeds as high as  $\frac{1}{4,000}$  s ( $\frac{1}{8,000}$  s when shooting in **Ultra HS**) by zooming the camera all the way out and selecting the smallest aperture (largest f-number).

## M: Manual

In manual exposure mode, the user controls both shutter speed and aperture. Shutter speed can be set to values between 8 s and  $\frac{1}{4,000}$  s in increments equivalent to 1 EV (one step), or the shutter can be held open for long time exposures of up to ten minutes (see opposite). Aperture can be set to values between the minimum and maximum in increments equivalent to  $\frac{1}{3}$  EV ( $\frac{1}{3}$  step).

1

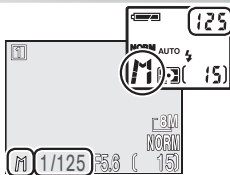
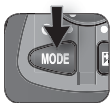

Select shutter speed or aperture. Selected item changes each time **MODE** button is pressed (selected item highlighted in green in shooting display).

2

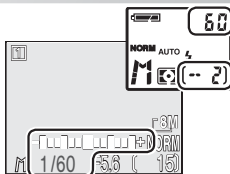

Set selected item. Exposure displays show amount picture will be under- or over-exposed at current setting.

3

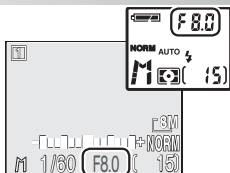
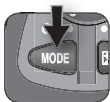

Select remaining item (aperture or shutter speed). Repeat steps 2–3 until desired exposure is achieved.

## Understanding the Exposure Displays

The exposure displays show the amount pictures will be under- or over-exposed at the values currently selected for shutter speed and aperture.

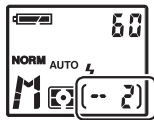

The control panel display is in EVs, rounded to the nearest EV. If the picture would be under- over-exposed by more than 9 EV, the display will show a flashing -9 (underexposure) or +9 (overexposure). If no operations are performed for about eight seconds, the display in the control panel will be replaced by the number of exposures remaining.

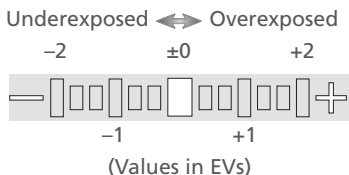

The exposure display in the monitor or electronic viewfinder shows the amount exposure deviates from the value suggested by the camera in EVs (-2 to +2 EV in increments of 1/3 EV).



## Long Time Exposures

For long time exposures of up to ten minutes, set **Continuous** ( 80) to **Single** and rotate the command dial to select a shutter speed of BULB or TIME. The length of time the shutter will remain open depends on the option selected for **Exposure options > Bulb/Time** ( 92):

- **Bulb release:** When BULB is selected for shutter speed, the shutter will remain open for as long as the shutter-release button is held down, to a maximum of ten minutes.
- **Timed release:** When TIME is selected for shutter speed, the shutter will open when the shutter-release button is pressed and remain open until the shutter-release button is pressed again or the time selected in the **Timed release** menu has elapsed.

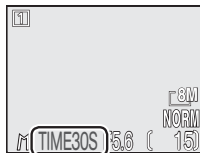
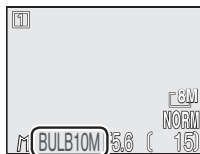

If possible, use a tripod to prevent blurring caused by camera shake. To reduce motting, use noise reduction ( 101).

## ISO Sensitivity (Shooting Modes 1 and 2 Only)

More on Photography

○ Sensitivity (ISO equivalency) is the digital equivalent of film speed. The higher the sensitivity, the less light needed to make an exposure, allowing higher shutter speeds and smaller apertures. Much as film with a high ISO rating tends to produce “grainy” images, high sensitivities may be associated with “noise”—randomly spaced, brightly colored pixels concentrated in dark parts of the image. Noise reduction (🔇 101) can be used to reduce noise in pictures taken at shutter speeds of 1/4 s or slower.

In 📷 (auto) and scene modes, the camera automatically raises sensitivity when lighting is poor. In shooting modes 1 (Custom 1) and 2 (Custom 2), the following options are available:

Option	Description
50	Approximately equivalent to ISO 50. Recommended unless lighting is poor or faster shutter speeds are required (e.g., when the subject is moving). Noise may appear in pictures taken at settings above this value.
100	Approximately equivalent to ISO 100.
200	Approximately equivalent to ISO 200.
400	Approximately equivalent to ISO 400. Intended for use with natural lighting; not recommended when using flash.
AUTO	Approximately equivalent to ISO 50 under normal conditions; when lighting is poor, however, camera automatically compensates by raising sensitivity to maximum of ISO 200 equivalent (🔇 36).

To choose a value for sensitivity:

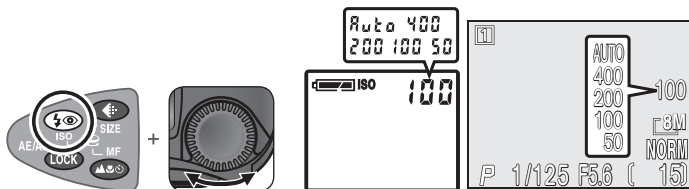

Press button and rotate command dial until desired setting is displayed. At settings other than **AUTO**, sensitivity is shown in shooting display during shooting.

### Exposure Mode

If **AUTO** is selected in shutter-priority auto or manual exposure mode, sensitivity will be fixed at ISO 50 equivalent and will not vary with lighting conditions.

## MF Manual Focus (Shooting Modes 1 and 2 Only)

In shooting modes 1 (Custom 1) and 2 (Custom 2), manual focus is available for situations in which the desired results can not be achieved using autofocus. Focus distance can be selected from preset values ranging from 3 cm (1") to infinity.

1

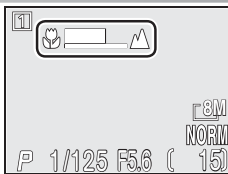
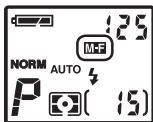
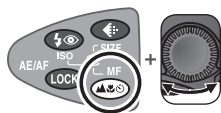

Press MF (MF) button and rotate command dial until subject is in focus. Focus position (distance from lens) shown by manual focus display in monitor or electronic viewfinder. M-F icon displayed in control panel.

2

Confirm focus in shooting display. Unless Off is selected for **Focus options > Focus confirmation** (94), focus confirmation turns on automatically when manual focus is in effect, and objects that are in focus will be sharply outlined.

3



Take pictures.

### ✎ Cancelling Manual Focus

To cancel manual focus, press the MF (MF) button to select another focus mode.

### ✎ Using the Self-Timer

When using manual focus with the self-timer, select self-timer mode before focusing.

### ✎ Close-Ups

Minimum focus distance varies with zoom position. At some positions, the camera may be unable to focus at very short distances (the ∞ end of the manual focus display). If the camera is unable to focus at the current zoom position, the manual focus display will turn red.

### ✎ Focus Lock

The LOCK button can not be used to lock focus in manual focus mode.

### ✎ Converter Lenses

Use autofocus with optional converter lenses (137).

**Image Adjustment (Shooting Modes 1 and 2 Only)**

The shooting menu includes options for controlling white balance, sharpness, contrast, and color saturation. These settings, which are available only in shooting modes 1 and 2 ( 40), can be adjusted according to shooting conditions and the user's creative intent.

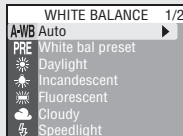
**White Balance ( 76)**

Adjust white balance for natural coloration under different types of lighting.

**Image Adjustment ( 86)**

Adjust contrast according to the scene and how the picture will be used.

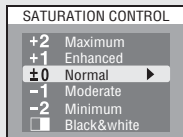

**Saturation Control ( 87)**

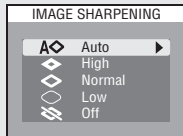
Take pictures in black-and-white, or adjust vividness for printing or for retouching in an imaging application.

**Image Sharpening ( 89)**

Sharpen or soften outlines.

**Keep or Delete (Quick Delete)**

While pictures are being recorded at an image quality of HI or at a **Continuous** setting of **Ultra HS**, a  → DELETE (quick delete) icon will be displayed in shooting display. To delete pictures before they are recorded to the memory card, press the  button. A confirmation dialog will be displayed; press the multi selector up or down to highlight an option and then press the multi selector to the right to make a selection.

- **Yes:** Delete the picture and return to shooting mode
- **No:** Exit to shooting mode without deleting the picture



Erase 1 image?

No   
Yes

## Movie Options (Shooting Modes **1** and **2** Only)

In shooting modes **1** (Custom 1) and **2** (Custom 2), the camera can record the following types of movie. All movies except time-lapse movies include sound recorded via the built-in microphone; the exposure mode is fixed at **P** (programmed auto) in all movie modes.

Option	Description
<b>TV movie (640)</b>	Movies are recorded at 30 frames per second. Each frame is 640×480 pixels in size with vertical interlacing. Maximum length for TV movies is 35 s.
<b>Small movie (320)</b>	Movies are recorded at 15 frames per second. Each frame is 320×240 pixels in size. Maximum length for small movies is 180 s.
<b>Time-lapse movie</b>	Camera takes still pictures at specified intervals and joins these frames to create silent movie with frame rate of 30 fps and frame size of 640×480. Resulting movie may be up to 35 s (1050 frames) long. Use to create time-lapse movies of slow processes that can be filmed without moving camera: flowers opening, butterfly emerging from cocoon, moving clouds, etc.
<b>Sepia movie 320</b>	Movies are recorded in sepia at 5 frames per second. Each frame is 320×240 pixels in size. Maximum length for sepia movies is 180 s.

### Movie Files

Movies are recorded as QuickTime movie files with the extension “.MOV” and names consisting of “INTN” (time-lapse movies) or “DSCN” (other movies) plus a four-digit file number assigned by adding one to the highest file number in the current folder (e.g., “INTN0001.MOV” or “DSCN0015.MOV”). Movies can be played back on a computer after transfer.

To choose the type of movie that will be recorded:

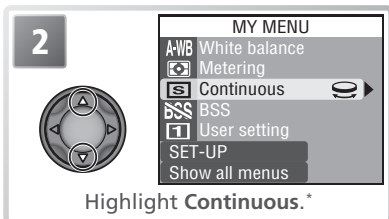
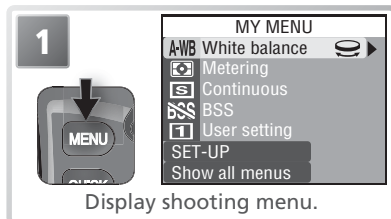

\* If **Continuous** option is not available in MY MENU, select **Show all menus** and highlight **Continuous** in full shooting menu (74–75).

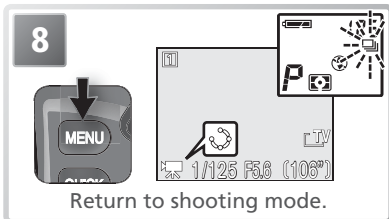
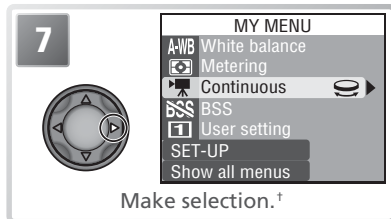
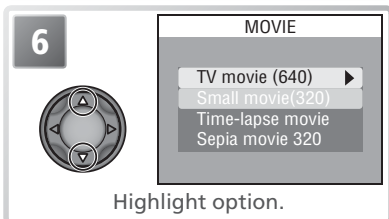
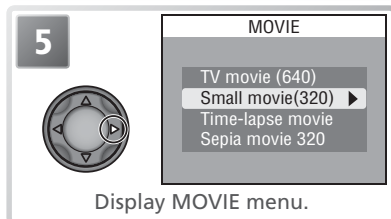
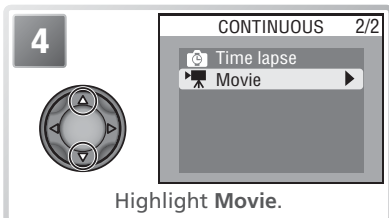
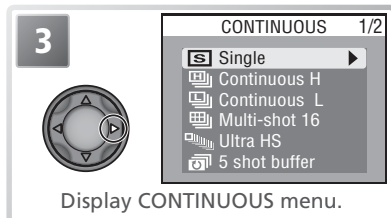

† If **Time lapse movie** is selected, time-lapse-movie menu will be displayed (52).



# Recording Movies

To record a TV movie, small movie, or sepia movie:





- 1 Slide the mode selector to  and turn the camera on

The exposure count display in the monitor shows the maximum total length of the movie that can be recorded.

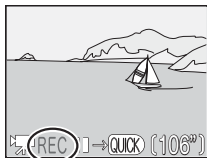

- 2 Start recording  
Press the shutter-release button all the way down to start recording.



While recording is in progress, a **REC** indicator will be displayed. To pause recording, press the  button. Recording will resume when the  button is pressed again.



- 3 End recording  
Press the shutter-release button all the way down a second time to end recording. Recording will end automatically when the memory card is full or the movie has reached maximum length.

## Zoom

Adjust optical zoom before recording TV movies, small movies, or sepia movies. Once recording has begun, pressing the zoom buttons will activate digital zoom (maximum 2x), even if **Off** is selected for **Zoom options > Digital tele**  95).

## Using the Flash

The Speedlight turns off when **TV movie (640)**, **Small movie (320)**, or **Sepia movie 320** is selected.

## Focus Mode

If **Single AF** (the default option) is selected for **Focus options > Auto-focus mode**  94), focus will lock when the shutter-release button is pressed to start recording.

## Recording a Time-Lapse Movie

Selecting **Time-lapse movie** from the MOVIE menu displays the menu shown in Step 1, below.

1



TIME-LAPSE MOVIE

 Set interval time  
 AE lock

Highlight **Set interval time**.

2



SET INTERVAL TIME

 30s  
 1m  
 5m  
 10m  
 30m  
 60m

Display menu of interval options.

3



SET INTERVAL TIME

 30s  
 1m  
 5m  
 10m  
 30m  
 60m

Choose interval between frames from **30s** (thirty seconds), **1m** (one minute), **5m** (five minutes), **10m** (ten minutes), **30m** (thirty minutes), and **60m** (sixty minutes).

4



MY MENU

 A-WB White balance  
 Metering  
 Continuous  
 BSS  
 1 User setting  
 SET-UP  
 Show all menus

Make selection and return to shooting menu. To change AE lock option, select **Continuous > Movie > Time lapse movie**. To exit without changing AE lock option, proceed to Step 9.

5



TIME-LAPSE MOVIE

 Set interval time  
 AE lock

Highlight **AE lock**.

6



AE LOCK



 Off  
 On

Display **AE LOCK** menu.

### Take a Test Shot

Take a test shot and view the results before beginning recording.

**7**

Choose **On** to fix exposure and auto white balance for entire movie at values for first frame, **Off** to meter new values for exposure and white balance with each shot.

**8**

Make selection.

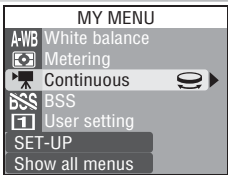
**9**



Return to shooting mode.

**10**



Start recording. Camera will take pictures at specified interval until shutter-release button is pressed again, memory card is full, or movie has reached maximum length.

**Use a Reliable Power Source**

If possible, use the optional EH-53 AC adapter when recording time-lapse movies.

**During Recording**

To save power, the monitor, viewfinder, and control panel turn off between frames. The displays turn on automatically immediately before the camera takes the next shot.

**Image Quality**



The file size of time lapse movies varies greatly depending on the option selected for image quality. If HI or RAW is selected, image quality will automatically be set to FINE.

**AE Lock**

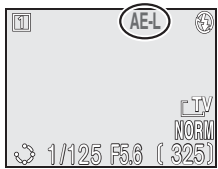





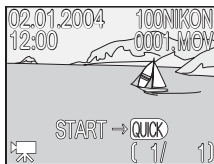

When **On** is selected for **AE lock**, a yellow AE-L icon will be displayed in the monitor, indicating that exposure and white balance will be locked with the first shot. Once the first shot is taken, the icon will turn white.



## Viewing Movies

To play a movie back, slide the mode selector to  and display the movie in full-frame playback (movie files are indicated by a  icon). Press the **QUICK** button to begin playback. If the movie was recorded with the **TV movie (640)**, **Small movie (320)**, or **Sepia movie 320** option, sound recorded with the movie will be played back over the camera's built-in speaker.



To	Press	Description
Start/pause/resume playback		Press <b>QUICK</b> button to start playback. While playback is in progress, pressing <b>QUICK</b> button pauses playback. Press again to resume. When movie ends, first frame of movie will be displayed.
Rewind movie one frame		When movie is paused, pressing multi selector up or left rewinds movie one frame.
Advance movie one frame		When movie is paused, pressing multi selector down or right advances movie one frame.
Raise volume		Volume indicator displayed in monitor when zoom buttons are pressed. Four levels are available: high (  ) , medium (  ) , low (  ) , and mute (  ) .
Lower volume		

### Quick Review/Full-Screen Review

Movies can not be played back in quick review or full-screen review ( 21).

### Direct Print

Movies can not be printed via direct USB connection ( 69).

## Viewing Pictures on the Camera

### Full-Frame Playback

To view the pictures on the memory card full-frame in the monitor (full-frame playback), slide the mode selector to .

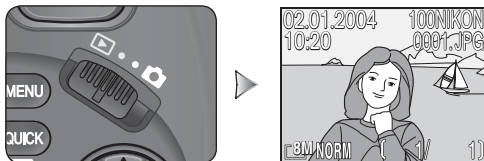

### Viewing Additional Pictures

Press the multi selector down or right to view pictures in the order recorded, up or left to view pictures in reverse order. Keep the multi selector pressed to scroll rapidly to the desired frame number.

### Photo Information

Press the **DISP** button to hide or view photo information ( 58).

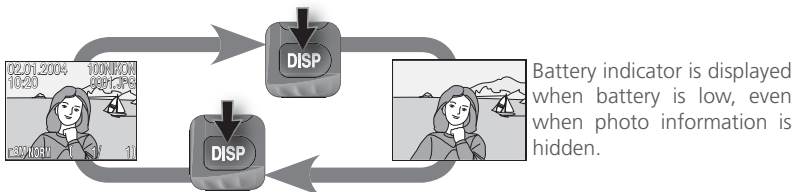

### Deleting the Current Picture

To delete the picture displayed in the monitor, press the  button. A confirmation dialog will be displayed; press the multi selector up or down to highlight an option and then press the multi selector to the right to make a selection.

- **Yes:** Delete the picture and return to playback mode
- **No:** Exit to playback mode without deleting the picture



### Quick Review/Full-Screen Review

To view pictures without leaving shooting mode, press the **QUICK** button ( 21).

## Creating HI-Quality Copies of RAW Images (Full-Frame Playback)

HI-quality (TIFF) copies can be created from RAW-quality images, allowing the pictures to be viewed in any application that supports TIFF. The copy will have the same file name as the original, with “.TIF” in place of the extension “.NEF” (if the original is named “DSCN0001.NEF,” the copy will be named “DSCN0001.TIF”). To create a copy, slide the mode selector to  and follow the steps below.

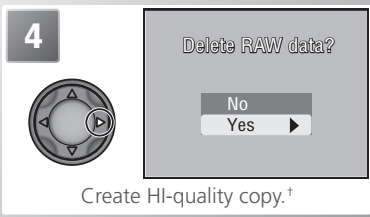
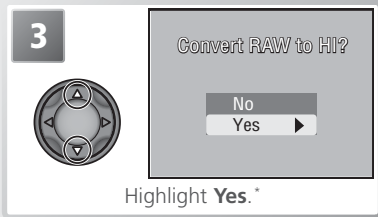
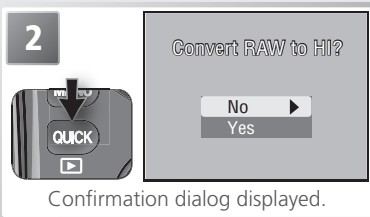
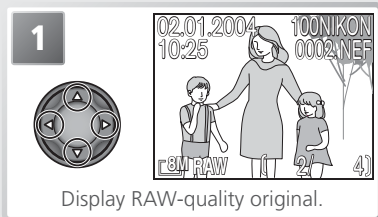

\* To exit without creating copy, highlight **No** and press multi selector right.

†  icon displayed during copying. Wait until copying is complete.

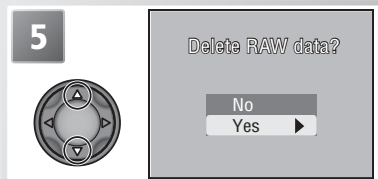

Highlight option.

- **No**: exit without deleting original
- **Yes**: delete original

Press multi selector to right to select highlighted option and return to full-frame playback.

### Creating HI-Quality Copies









Before creating a copy, switch to shooting mode, select HI image quality, and check the number of exposures remaining to confirm that there is space on the memory card for at least one additional HI-quality image.

Voice memos recorded with RAW images are not copied, and will be lost if the original is deleted.

## Viewing Multiple Pictures: Thumbnail Playback

Pressing the  (w) button in full-screen review or full-frame playback displays the pictures on the memory card in “contact sheets” of four thumbnail images. The following operations can be performed while thumbnails are displayed:



To	Press	Description
Highlight pictures		Press multi selector up, down, left, or right to highlight pictures.
Page through pictures		Rotate the command dial to scroll through thumbnails a page at a time.
Change number of pictures displayed	 (w) / Q (T)	With four thumbnails displayed, press  (w) button once to view nine thumbnails. Press Q (T) to “zoom in” from nine- to four-thumbnail view or, when four thumbnails are displayed, to view highlighted picture full frame.
Delete highlighted picture		Confirmation dialog will be displayed. Press multi selector up or down to highlight option, press to right to select. <ul style="list-style-type: none"> <li>• Select <b>Yes</b> to delete picture</li> <li>• Select <b>No</b> to exit without deleting picture</li> </ul> <div data-bbox="736 806 943 960" style="border: 1px solid black; padding: 5px; margin-top: 10px;"> <p>Erase 1 Image?</p> <p>No </p> <p>Yes</p> </div>
Exit to current mode		Return to full-frame playback with highlighted picture displayed full frame (full-frame playback) or return to shooting mode (full-screen review).
Create small copy	 Shutter button	Create small copy of highlighted picture (full-frame playback only; not available in full-screen review). See “Creating Small Copies: Small Picture” (  62).

## Photo Information

In full-screen review and full-frame playback, information about each picture is superimposed on the image. There are six pages of photo information for each picture. Rotate the command dial to cycle through photo information as follows: Page 1 ↔ Page 2 ↔ Page 3 ↔ Page 4 ↔ Page 5 ↔ Page 6 ↔ Page 1.

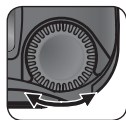

### Page 1 (File Information)



- |   |  |
|---|--|
| <ul style="list-style-type: none"> <li>1 Date of recording</li> <li>2 Time of recording</li> <li>3 Image size</li> <li>4 Folder</li> <li>5 File number and type</li> <li>6 Battery level indicator</li> <li>7 Voice memo icon</li> <li>8 Transfer icon</li> </ul> | <ul style="list-style-type: none"> <li>9 Print-order icon</li> <li>10 Protect icon</li> <li>11 Current frame number/ total number of frames visible in current folder</li> <li>12 Image quality</li> </ul> |
|---|--|

### Page 2 (Shooting Information)



- 1 Camera type
- 2 Firmware information
- 3 Metering mode
- 4 Exposure mode
- 5 Shutter speed
- 6 Aperture

### Page 3 (Shooting Information, continued)



- 1 Exposure compensation
- 2 Focal length
- 3 Focus mode
- 4 Flash status
- 5 Image adjustment
- 6 Sensitivity (ISO equivalency)



## Page 4 (Shooting Information, continued)



- 1 White balance
- 2 Color saturation
- 3 Sharpening
- 4 Digital zoom
- 5 Converter lens setting
- 6 File size

## Page 5 (Exposure Information)

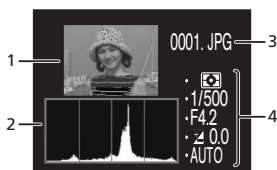

- 1 Thumbnail preview (flashing border marks image highlights—i.e., brightest areas of image)
- 2 Histogram (shows distribution of tones in image; horizontal axis corresponds to pixel brightness, with dark tones to left and bright tones to right, while vertical axis shows number of pixels of each brightness in image)
- 3 File number and type
- 4 Exposure information (metering, shutter speed, aperture, exposure compensation, sensitivity)

## Page 6 (Focus Confirmation)



- 1 File number and type
- 2 Focus information (focal length, shutter speed, aperture, focus mode, noise reduction)
- 3 Focus confirmation (areas of picture that are in focus are sharply outlined; active focus area is shown in red)

## ▶ Taking a Closer Look: Playback Zoom

Use the Q (T) button to zoom in on still pictures displayed in full-screen review or full-frame playback.

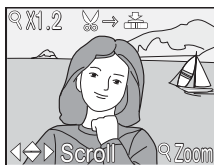

To	Press	Description
Zoom in	Q (T)	Zoom increases each time button is pressed, to a maximum of 6x. While image is zoomed in, Q icon and zoom ratio are displayed in top left corner of monitor.
View other areas of picture		Use multi selector to scroll to areas of picture not visible in monitor. To use multi selector to view other pictures, cancel zoom.
Zoom out		Zoom decreases each time button is pressed. To cancel zoom, zoom picture out until entire picture is displayed.
Cancel zoom		Cancel zoom and return to full-frame playback or shooting mode (full-screen review).
Create cropped copy (full-frame playback only)	 Shutter button	<p>If  →  icon is displayed at top of monitor, cropped copy of current picture can be created by pressing shutter-release button. Confirmation dialog will be displayed; press multi selector up or down to highlight option, press to right to select.</p> <ul style="list-style-type: none"> <li>• Select <b>Yes</b> to create new picture containing only area visible in monitor</li> <li>• Select <b>No</b> to exit without creating cropped copy</li> </ul>

Save this image as displayed?

No ▶

Yes

## Playback Zoom

Playback zoom is not available with movies or with copies created using the small picture option.

Additional time is required to display RAW- or HI-quality images. If a message is displayed when the **Q** button is pressed to zoom in on the image, wait until the message clears from the display and then try again.

## Cropping Pictures

Copies may not display or transfer correctly when viewed on other models of Nikon digital camera. Cropping is not available with RAW or HI-quality images, pictures taken at an image size of **3:2** (3,264 × 2,176), pictures created using panorama assist, movies, pictures created using the **Ultra HS** or **Time lapse** options in the **Continuous** menu, cropped copies, or copies created using the small picture option. Copies can only be created if sufficient space is available on the memory card.

## Cropped Copies

Cropped copies are stored as NORMAL-quality JPEG files and have the same time and date of creation as the original. Depending on the size of the original and the zoom ratio at the time the copy was created, copies will be 3,264 × 2,448 (**r8M**), 2,592 × 1,994 (**r5M**), 2,048 × 1,536 (**r3M**), 1,600 × 1,200 (**r2M**), 1,280 × 960 (**r1M**), 1,024 × 768 (**rPC**), 640 × 480 (**rTV**), 320 × 240 (**rL**), or 160 × 120 (**rS**) pixels in size. Copies are stored in separate files on the memory card with names of the form "RSCNnnnn.JPG," where "nnnn" is a four-digit number assigned automatically by the camera. Copies are independent of the originals: deleting the copy has no effect on the original, deleting the original no effect on the copy. Copies are created with the same transfer marking as the original, but any subsequent changes to transfer marking or to protect, hide, and print attributes must be made separately.

## ▶ Creating Small Copies: Small Picture

To create a small copy of the picture currently displayed in full-frame playback or highlighted in the thumbnail list, press the shutter-release button.

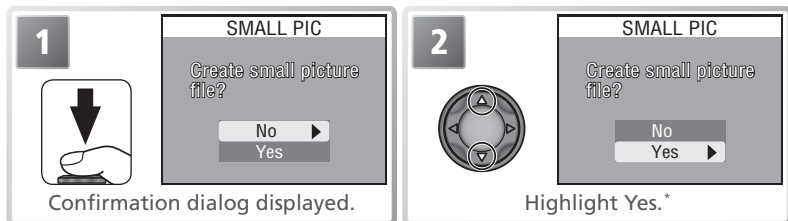

\* To exit without creating small copy, highlight **No** and press multi selector to right.

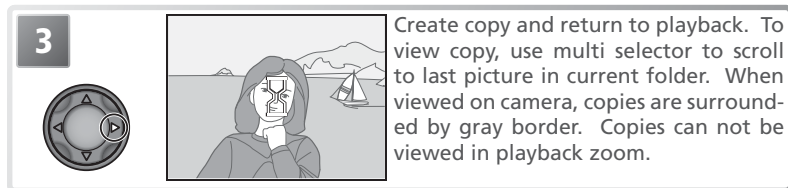

Depending on the option selected for **Small pic** in the playback menu (121), copies will be 640 × 480 (TV), 320 × 240 (L), or 160 × 120 (S) pixels in size. Small copies are stored as BASIC-quality JPEG files, making them ideal for distribution by e-mail or for use in web pages.

### ✎ Small Copies









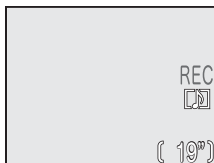







Copies are stored as files with names of the form "SSCNnnnn.JPG," where "nnnn" is a four-digit number assigned automatically by the camera. Copies are independent of the originals: deleting the copy has no effect on the original, deleting the original no effect on the copy. Copies are created with the same transfer marking and date and time of recording as the original, but any subsequent changes to transfer marking or to protect, hide, and print attributes must be made separately.

Copies may not display or transfer correctly when viewed on other models of Nikon digital camera. Small copies can not be created in full screen review or playback zoom. Copies can not be created from RAW or HI-quality images, pictures with a size of [3:2] (3,264 × 2,176), movies, pictures created using panorama assist or the **Ultra HS** or **Time lapse** options in the **Continuous** menu, cropped copies, or other small copies. Copies can only be created if sufficient space is available on the memory card.

## Voice Memos: Recording and Playback

Brief voice memos can be added to pictures displayed in full-frame playback (55). Voice memos can not be added to movies. Memos are stored on the memory card as WAV-format sound files. During playback, the presence of a memo is indicated by a  icon.



To	Press	Description
Record memo		Memo of up to 20s can be recorded while  button is pressed. Recording ends after about 20s or when  button is released.
Play memo		If  icon appears in file information display during playback, memo can be played back over the built-in speaker by pressing  button. Playback ends when entire recording has been played back or  button is pressed a second time.
Pause/resume playback		Press  button to pause playback. Press again to resume.
Raise volume		Volume indicator displayed in monitor when zoom buttons are pressed. Four levels are available: high (  ) , medium (  ) , low (  ) , and mute (  ) .
Lower volume		
Delete picture or voice memo		Confirmation dialog will be displayed. Press multi selector up or down to highlight option, press to right to select. <ul style="list-style-type: none"> <li>• Select <b>Yes</b> to delete both picture and voice memo</li> <li>• Select  to delete voice memo only</li> <li>• Select <b>No</b> to exit without deleting picture or voice memo</li> </ul>



## Viewing Pictures on TV

The EG-E5000 audio/video (A/V) cable included with the camera can be used to connect the camera to a television or video-cassette recorder (VCR).

### Choosing a Video Mode

The **Video mode** item in the setup menu offers a choice of NTSC and PAL (135). Be sure that the mode selected matches the standard used by the video device.

**1 Turn the camera off**  
Turn the camera off before connecting or disconnecting the A/V cable.

**2 Connect the A/V cable**  
Insert the black plug into the camera's A/V-out connector. Insert the yellow plug into the video-in jack on the television or VCR. Connect the white plug to the audio-in jack.

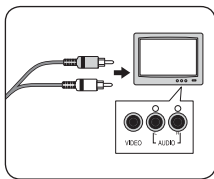
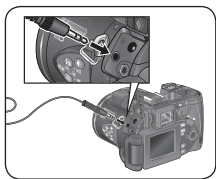

**3 Tune the television to the video channel**  
If in doubt, consult the documentation for your television or VCR.

**4 Slide the mode selector to **



**5 Turn the camera on**  
The camera monitor will remain off and the television will show the image normally shown in the monitor.

### PAL

If **PAL** is selected for **Video mode** while the camera is connected to a video device, video output will be suspended and the camera monitor or electronic viewfinder will turn on while movies are being recorded or pictures are being taken with **Continuous** set to **Ultra HS**.

## Viewing Pictures on a Computer

Using the UC-E1 USB cable and PictureProject software, you can view photographs and movies on a computer. Before pictures can be transferred (copied) to your computer, PictureProject must be installed. For more information on installing PictureProject and transferring pictures to a computer, see the documentation on the reference CD and the *Quick Start Guide*.

### Before Connecting the Camera

Before transferring pictures to a computer, set the **USB** option in the camera setup menu to match the computer's operating system (▶ 134). The camera supports two options: **Mass storage** (the default option) and **PTP** (Picture Transfer Protocol).

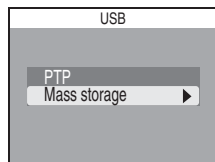

Operating system	USB option
Windows XP Home Edition Windows XP Professional Mac OS X (10.1.5 or later)	Choose <b>Mass storage</b> or <b>PTP</b> .
Windows 2000 Professional Windows Millennium Edition (Me) Windows 98 Second Edition (SE)	Choose <b>Mass storage</b> .

## ▶ Connecting the USB Cable

Turn the camera on and wait for it to start up. After confirming that the camera is off, connect the UC-E1 USB cable as shown below. Connect the camera directly to the computer; do not connect the cable via a USB hub or keyboard.

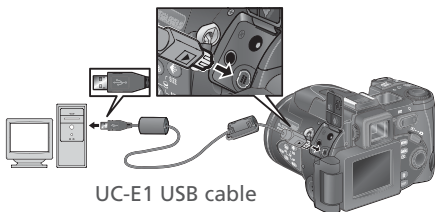

When the camera is turned on, the lens will extend and [ ] will be displayed in the control panel. All controls except the power switch will be inactive.

### ✎ **Windows 2000 Professional, Windows Millennium Edition (Me), Windows 98 Second Edition (SE)**

DO NOT select **PTP** when connecting the camera to a computer running one of the above operating systems. If you have connected the camera to a computer running one of the above operating systems with **PTP** selected in the **USB** menu, disconnect the camera as described below. Be sure to select **Mass storage** before reconnecting the camera.

#### **Windows 2000 Professional**

A dialog will be displayed welcoming you to the Found New Hardware Wizard. Click **Cancel** to close the dialog, and then disconnect the camera.

#### **Windows Millennium Edition (Me)**

After displaying a message stating that the hardware information database is being updated, the computer will start the Add New Hardware Wizard. Click **Cancel** to exit the wizard, and then disconnect the camera.

#### **Windows 98 Second Edition (SE)**

The Add New Hardware Wizard will be displayed. Click **Cancel** to exit the wizard, and then disconnect the camera.



## Disconnecting the Camera

If **PTP** is selected in the **USB** menu, the camera can be turned off and the USB cable disconnected once transfer is complete. If the **USB** option in the camera setup menu is still at its default setting of **Mass storage**, the camera must first be removed from the system as described below.

### *Windows XP Home Edition/Windows XP Professional*

Click the "Safely Remove Hardware" icon (🔌) in the taskbar and select **Safely remove USB Mass Storage Device** from the menu that appears.



### *Windows 2000 Professional*

Click the "Unplug or Eject Hardware" icon (🔌) in the taskbar and select **Stop USB Mass Storage Device** from the menu that appears.



### *Windows Millennium Edition (Me)*

Click the "Unplug or Eject Hardware" icon (🔌) in the taskbar and select **Stop USB Disk** from the menu that appears.



### *Windows 98 Second Edition (SE)*

In My Computer, click with the right mouse button on the removable disk corresponding to the camera and select **Eject** from the menu that appears.



### *Mac OS X*

Drag the "Untitled (Unlabeled)" camera volume into the Trash.

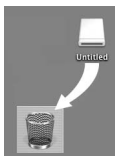

## Printing Pictures

**To print the pictures from the camera memory card:**

- select pictures for printing using the **Print set** option and take the memory card to a digital print service center (📷 116)
- select pictures for printing using the **Print set** option and insert the memory card into a personal photo printer equipped with a card slot (📷 116)
- use the USB cable to connect the camera to a PictBridge-compatible printer and print pictures directly from the camera (📷 69)
- transfer the pictures using PictureProject and print them from a computer (see the documentation on the reference CD)

**To print the time and date of recording on pictures:**

- take pictures using the **Date imprint** option in the setup menu, which imprints the date or date and time of recording directly on pictures as they are taken (📷 136)
- if the photo printer or print service supports Digital Print Order Format (DPOF), use the **Date** option in the **Print set > Print selection** menu (📷 116)
- transfer the pictures using PictureProject and print them using the date imprint option (see the documentation on the reference CD)

### "Print Set" and Digital Print Order Format (DPOF)

The **Print set** option in the playback menu is used to create a digital "print order" listing the pictures to be printed, the number of prints, and the information to be included on each print. This print order is stored on the camera memory card in Digital Print Order Format (DPOF). Once a print order has been created, the memory card can be inserted in a DPOF-compatible device and the pictures printed directly from the card. Before using this option, check that the printer or print service supports DPOF. Note that:

- If the **Print set** option has not been used to create a print order, one copy of all the pictures on the memory card will be printed

### "Date Imprint" Versus the Print Set "Date" Option

Date imprint	Print selection > Date
Must be set before picture is taken	Set after picture is taken
Date permanently imprinted on picture	Date stored separately
Date appears whenever picture is printed	Date only appears when picture is printed on DPOF-compatible printer

## Printing Via Direct USB Connection

When the camera is connected to a PictBridge-compatible printer via the UC-E1 USB cable, selected pictures can be printed directly from the camera memory card.

### Step 1

Set the USB option to PTP (P 69)



### Step 2

Connect the USB Cable (P 70)



### Step 3

#### Print

- Print selected pictures (P 70)
- Print DPOF print order (P 72)

## Step 1—Set the USB Option to PTP

Before pictures can be printed via direct USB connection, the **USB** option in the setup menu must be set to **PTP** (P 134; the default option is **Mass storage**). Be sure to change the USB option *before* connecting the printer.

### Before Printing

Before printing via direct USB connection, check printer settings and make sure that the printer supports PictBridge. See the printer manual for details.

### Pictures That Can Not Be Printed by Direct USB Connection

Movies and RAW-quality pictures (P 30) can not be printed via direct USB connection. Some printers may not support direct printing of HI-quality (TIFF) images; consult the documentation provided with the printer for more information.

### Use a Reliable Power Source

When printing pictures via direct USB connection, be sure the battery is fully charged. If in doubt, recharge the battery before printing or use the optional EH-53 AC adapter.

### PictBridge

PictBridge is an industry standard that ensures compatibility between cameras and printers, allowing pictures to be printed directly from the camera without using a computer.

## Step 2—Connect the USB Cable

After confirming that the camera is off, connect the UC-E1 USB cable as shown below.

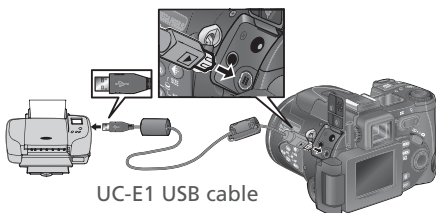

Turn the camera and printer on. The menu shown at right will be displayed in the camera monitor.

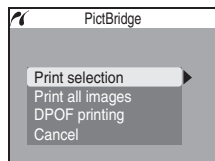

## Step 3—Print

To print selected pictures:

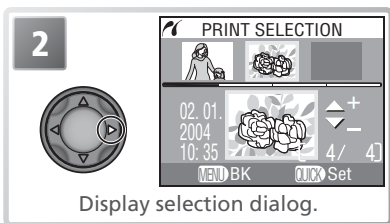
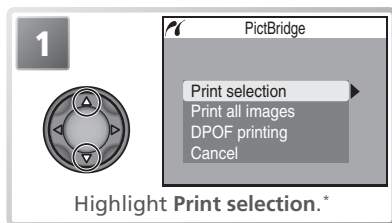

\* To print one copy of each picture on memory card, highlight **Print all images** and press multi selector to right. Select **Cancel** to exit without printing pictures.

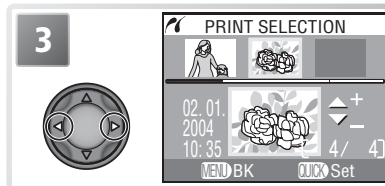

Scroll through pictures. Current picture shown at bottom of display.

4

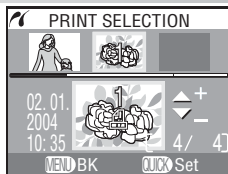

Select current picture and set number of prints to 1. Selected pictures marked by icon.

5

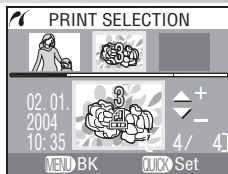

Use multi selector to specify number of prints (up to 9). To deselect picture, press multi selector down when number of prints is 1. Repeat steps 3–5 to select additional pictures.

6

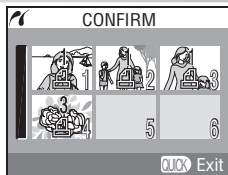

View selected pictures. Press multi selector up, right, left, or down to view pictures not visible in display. After confirming selection, press button again to proceed to next step.

7

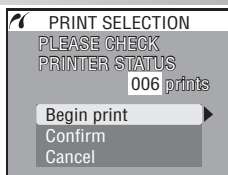

Highlight **Begin print**.\*

8

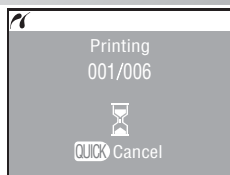

Start printing.†

\* Select **Confirm** to return to Step 6, **Cancel** to exit without printing pictures.

† Press button to interrupt printing before all pictures have been printed.

9

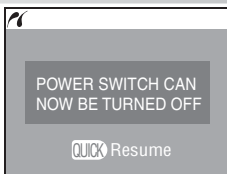

Message shown at left is displayed when printing is complete. Turn camera off and disconnect USB cable, or press button to return to Step 1.

The **Print set** option in the playback menu can be used to create a digital “print order” that specifies the pictures to be printed, the number copies of each print, and the information to be included on the prints (116). To print the current print order:

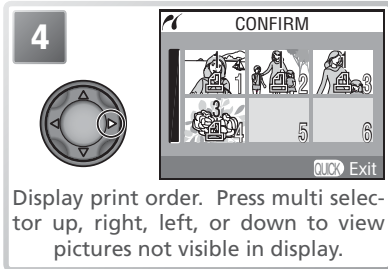
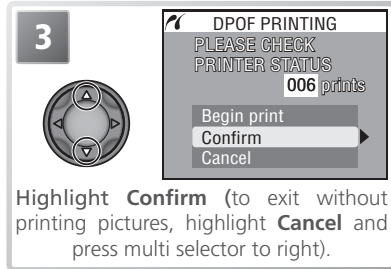
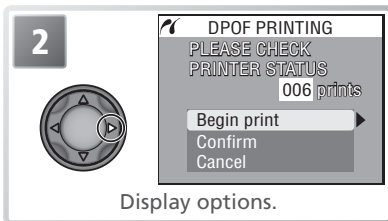
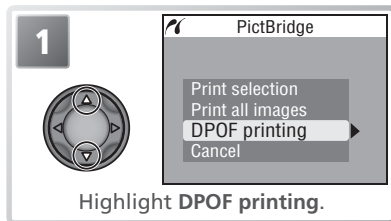

### DPOF Printing

The **DPOF printing** option is only available if a print order has been created.

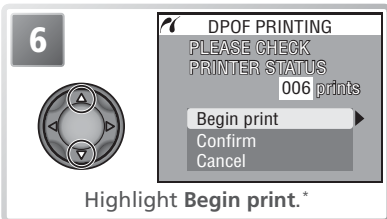
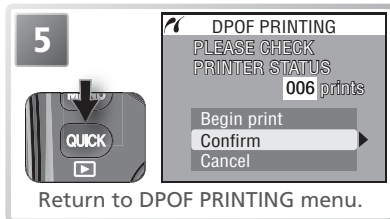

\* Select **Confirm** to return to Step 4, **Cancel** to exit without printing pictures.

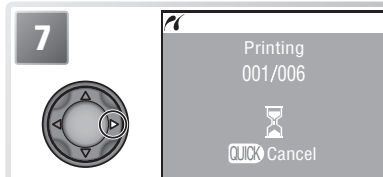

Start printing. To interrupt printing before all images have been printed, press **QUICK** button and then turn camera off and disconnect USB cable.

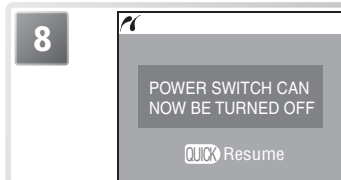

Message shown at left is displayed when printing is complete. Turn camera off and disconnect USB cable, or press **QUICK** button to return to Step 1.

## Error Messages

If the dialog shown at right is displayed, an error has occurred. After checking the printer and resolving any problems as directed in the printer manual, highlight **Resume** and press the multi selector to the right to resume printing. Select **Cancel** to exit without printing the remaining images.

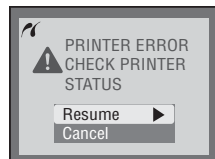

# Menu Guide

## The Shooting Menu (Shooting Modes 1 and 2 Only)

In shooting modes 1 (Custom 1) and 2 (Custom 2), the settings listed opposite can be adjusted from the shooting menu. To display the shooting menu, slide the mode selector to and follow the steps below.

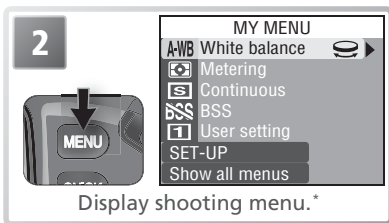
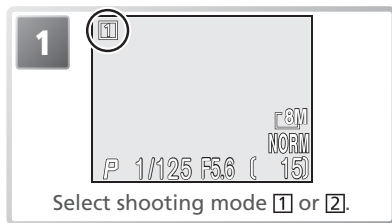

\* Illustration shows default menu.

Pressing the button displays a one-page custom menu containing five items selected from a total of nineteen options available in the full shooting menu (at default settings, the options displayed are **White balance**, **Metering**, **Continuous**, **BSS**, and **User Setting**). The items that appear in the custom menu can be selected using the **My menu** option ( 103). To display the full shooting menu, which consists of three pages of options:

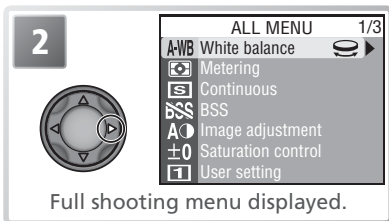
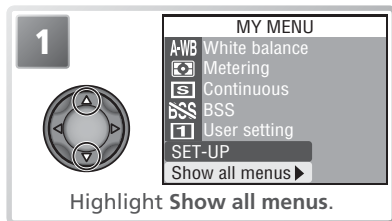



The full shooting menu contains the following options:

ALL MENU 1/3	
<b>A-WB</b> White balance	
Metering	
Continuous	
BSS	
Image adjustment	
$\pm 0$ Saturation control	
User setting	

ALL MENU 1/3		
White balance	76–78	
Metering	79	
Continuous	80–83	
BSS	84–85	
Image adjustment	86	
Saturation control	87	
User setting	88	

ALL MENU 2/3	
<b>A</b> Image sharpening	
Lens	
Exposure options	
Focus options	
Zoom options	
Speedlight opt.	
<b>OFF</b> Auto bracketing	

ALL MENU 2/3		
Image sharpening	89	
Lens	90	
Exposure options	91–92	
Focus options	93–94	
Zoom options	95	
Speedlight opt.	96–98	
Auto bracketing	99–100	

ALL MENU 3/3	
<b>OFF</b> Noise reduction	
Reset	
My menu	
CF card format	
<b>SET-UP</b>	



ALL MENU 3/3		
Noise reduction	101	
Reset	102	
My menu	103	
CF card format	104	
SET-UP	122–136	

## The Icon





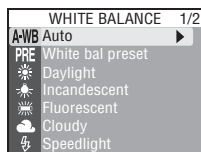

A icon appearing next to a highlighted option indicates that the selected option can be changed by rotating the command dial.

## White Balance

The color of the light reflected from an object varies with the color of the light source. The human brain is able to adapt to such changes in color, with the result that we see white objects as white, regardless of whether they are in the shade, direct sunlight, or under incandescent lighting. Digital cameras can mimic this adjustment by processing information from the camera's image sensor (CCD) according to the color of the light source. This process is known as a "white balance adjustment."

In  and scene modes, white balance is adjusted automatically to suit the selected scene. In shooting modes  and , white balance can be selected from the following options:



Option	Description
<b>A-WB Auto</b>	White balance automatically adjusted to suit lighting conditions. Recommended for most situations.
<b>PRE White bal preset</b>	White object used as reference to set white balance under unusual lighting conditions.
 <b>Daylight</b>	White balance adjusted for direct sunlight.
 <b>Incandescent</b>	Use under incandescent lighting.
 <b>Fluorescent</b>	Use under most types of fluorescent lighting.
 <b>Cloudy</b>	Use when taking pictures under overcast skies.
 <b>Speedlight</b>	Use with built-in Speedlight.
 <b>Shade</b>	Use under sunny skies when subject is in shade.

### White Balance

At settings other than **A-WB (Auto)**, white balance is shown by an icon in the shooting display.

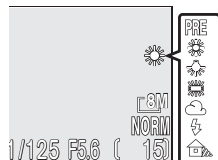

## Fine-Tuning White Balance

At settings other than **A-WB (Auto)** and **PRE (White bal preset)**, white balance can be “fine tuned” to compensate for variations in the color of the light source or to create pictures with a “warm” or “cold” cast. Except in the case of  (**Fluorescent**), adjustments can be made in the range +3 to -3 in increments of one. Higher settings can be used to lend images a bluish tinge or to compensate for light sources with a yellow or red cast. Lower settings can be used to make pictures slightly yellow or red or to compensate for light sources with a blue cast.

When white balance is set to  (**Fluorescent**), a menu of three different bulb types is available.

Option	Bulb type
<b>FL1</b>	White (W)
<b>FL2</b>	Daylight White/ Neutral (N)
<b>FL3</b>	Daylight (D)

To fine-tune white balance:

**1**





WHITE BALANCE 1/2

A-WB Auto

PRE White bal preset 

 Daylight ▶

 Incandescent

 Fluorescent

 Cloudy

 Speedlight

Highlight white balance option.

**2**





WHITE BALANCE 1/2

A-WB Auto

PRE White bal pres +1

 Daylight ±0 ▶

 Incandescent -1

 Fluorescent

 Cloudy

 Speedlight

Select value.

**3**





WHITE BALANCE 1/2

A-WB Auto

PRE White bal preset 

 Daylight ▶

 Incandescent

 Fluorescent

 Cloudy

 Speedlight

Make selection and return to shooting menu.

## PRE Preset White Balance

Preset white balance is used when shooting under mixed lighting or to compensate for light sources with a strong color cast (for example, to make pictures taken under a lamp with a red shade look as though they had been taken under white light). When **PRE (White bal preset)** is selected from the white-balance menu, the camera will zoom in and the menu shown above at right will be displayed.

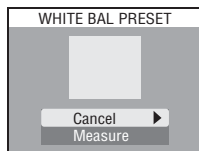

Option	Description
<b>Cancel</b>	Recalls the most recent value for preset white balance from memory and sets white balance to this value.
<b>Measure</b>	To measure a new value for white balance, place a white object, such as a piece of paper, under the lighting that will be used in the final picture. Frame this object so that it fills the square in the center of the menu shown above. Highlight <b>Measure</b> and press the multi selector to the right to measure a new value for white balance (the shutter will be released and the camera will return to the original zoom position, but no picture will be recorded).





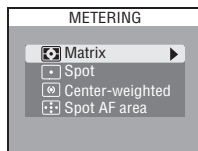

## Using the Flash

Preset white balance can not be measured with the flash.



## Metering

Choose a metering method suited to the composition and lighting conditions.



Option	How it works	When to use it
 <b>Matrix</b>	Camera compares measurements from 256 areas of frame with library of typical compositions to set exposure for entire frame.	Recommended for most situations.
 <b>Spot</b>	Camera meters area shown by square in center of monitor. Only about 1/32 of frame is metered.	Ensures that subject in metering target is correctly exposed even if background is much brighter or darker. Can be used with autoexposure lock (  20) to meter off-center subjects.
 <b>Center-weighted</b>	Camera meters entire frame but assigns weight of 80% to area in center of frame occupying roughly 1/4 of total.	Classic meter for portraits; preserves background details while letting lighting conditions at center of frame determine exposure. Can be used with autoexposure lock (  20) to meter off-center subjects.
 <b>Spot AF area</b>	Links spot metering to active focus area when auto or manual focus area selection is in effect (  93).	Use instead of autoexposure lock to meter off-center subjects. Matrix metering is used when focus-area selection is off.

### Metering



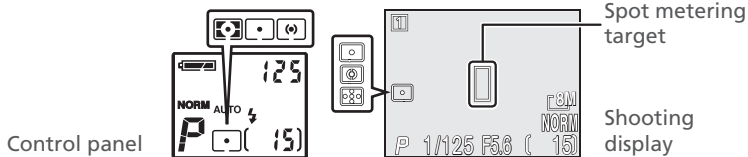





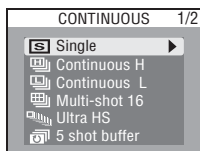





Metering is shown by icons in the control panel and shooting display. No icon appears in the shooting display when  (**Matrix**) is selected. When spot AF-area metering is selected, a  icon appears in the control panel.



## Continuous

Use the options in this menu to capture a fleeting expression on a portrait subject, photograph a subject that is moving unpredictably, or capture motion in a series of pictures.



Option	Description
 <b>Single</b>	Camera takes one picture each time shutter-release button is pressed.
 <b>Continuous H</b> <sup>1, 2</sup>	While shutter-release button is pressed, camera records up to 5 pictures at up to 2.5 fps. Monitor and electronic viewfinder turn off during shooting.
 <b>Continuous L</b> <sup>2, 3</sup>	Camera records up to 12 pictures at rate of up to 1.2 fps while shutter-release button is pressed. Shooting is suspended while  icon is displayed (  81).
 <b>Multi-shot 16</b> <sup>2, 3</sup>	Each time shutter-release button is pressed, camera takes 16 consecutive pictures 816×612 pixels in size at about 1.5 fps and arranges them in 4 rows to form a single picture measuring 3,264×2,448 pixels. Image size automatically set to  .
 <b>Ultra HS</b> <sup>4</sup>	While shutter-release button is pressed, camera records up to 100 pictures at rate of up to 30 fps. Image quality is automatically set to NORMAL and image size to  (640×480). With each sequence, camera creates new folder in which all photos in sequence are stored. Folder name consists of "N_" followed by three-digit sequence number assigned automatically by camera. Exposure count is shown in shooting display.
 <b>5 shot buffer</b> <sup>2, 3</sup>	Camera shoots at up to 1 fps while shutter-release button is pressed, but only last five shots are saved to memory card.
 <b>Time lapse</b> <sup>3</sup>	Camera takes pictures automatically at specified interval. See "Interval Timer Photography" (  82).
 <b>Movie</b> <sup>4</sup>	Camera records movies up to three minutes long. See "Movies" (  49).





1 HI image quality reset to FINE.

2 Built-in Speedlight turns off.

3 RAW and HI image quality reset to FINE.

4 Built-in and optional Speedlights turn off (**Movie > Time-lapse movie** excluded).

 **Other Camera Settings**

Settings other than **Single** can not be used in combination with BSS ( 84), white-balance bracketing ( 99), or noise reduction ( 101). **Multi-shot 16**, **Ultra HS**, **5 shot buffer**, **Time lapse**, and **Movie** can not be used in combination with auto-exposure bracketing ( 99). Digital zoom ( 16) can not be used at settings of **Multi-shot 16** or **Ultra HS**.

 **Focus, Exposure, and White Balance**

At settings other than **Single**, focus, exposure, and white balance are determined by the first picture in each series.

 **Ultra HS**



If the monitor is swivelled to point in the same direction as the lens during shooting, the display in the monitor will be inverted.

During shooting, progress is shown by the zoom indicator in the monitor, from **S** (start) to **E** (end). To interrupt shooting before one hundred pictures have been recorded, lift your finger from the shutter-release button.

 **The Memory Buffer**

During shooting, pictures are stored in a temporary memory buffer before being transferred to the memory card for permanent storage. You can continue to take pictures as long as room is available in the buffer. When the buffer is full, a  (wait) icon will be displayed and shooting will be suspended. More pictures can be taken as soon as enough memory becomes available in the buffer.

 **Continuous**

At settings other than **Single**, the current “continuous” setting is shown by an icon in the shooting display. At settings of **Continuous H**, **Continuous L**, **5 shot buffer**, and **Time lapse**, a  icon appears in the control panel. A  icon appears in the control panel when **Multi-shot 16** is selected; in **Ultra HS** and **Movie** mode, the  icon in the control panel flashes. At a setting of **Ultra HS**, the image-quality indicator (**NORM**) flashes in the control panel.



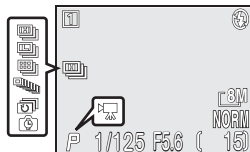
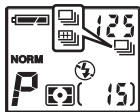





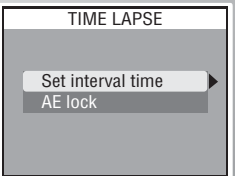

Control panel

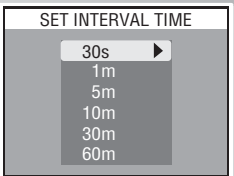

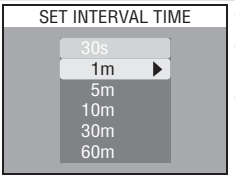
Shooting display

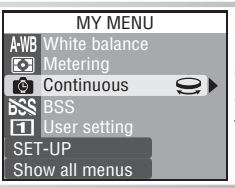
## Interval Timer Photography

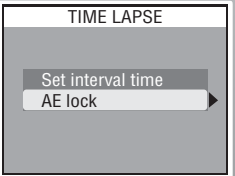
To display the menu shown in Step 1, below, highlight **Time lapse** in the CONTINUOUS menu and press the multi selector to the right.

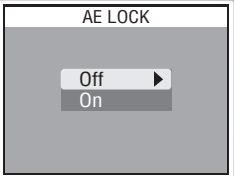
<p><b>1</b></p>  <p>Highlight <b>Set interval time</b>.</p>		<p><b>2</b></p>  <p>Display menu of interval options.</p>	
<p><b>3</b></p> 		<p>Choose interval between pictures from <b>30s</b> (thirty seconds), <b>1m</b> (one minute), <b>5m</b> (five minutes), <b>10m</b> (ten minutes), <b>30m</b> (thirty minutes), and <b>60m</b> (sixty minutes).</p>	
<p><b>4</b></p> 		<p>Make selection and return to shooting menu. To change AE lock option, select <b>Continuous&gt;Time lapse</b>. To exit without changing AE lock option, proceed to Step 9.</p>	
<p><b>5</b></p>  <p>Highlight <b>AE lock</b>.</p>		<p><b>6</b></p>  <p>Display AE LOCK menu.</p>	

## Take a Test Shot

Take a test shot and view the results before beginning recording.



7



Choose **On** to fix exposure and auto white balance for entire series at values for first picture, **Off** to meter new values for exposure and white balance with each shot.

8



Make selection.

9

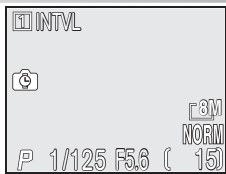

Return to shooting mode.

10



Start recording. Camera will take pictures at specified interval until shutter-release button is pressed again, memory card is full, or 1,800 pictures have been taken.

### Use a Reliable Power Source

To prevent shooting from ending unexpectedly, use the optional EH-53 AC adapter for interval timer photography.

### During Recording

To save power, the monitor and electronic viewfinder turn off between pictures. The display turns on automatically immediately before the camera takes the next shot.

### Folders

Each sequence of pictures is stored in a folder with a name consisting of a three-digit folder number followed by "INTVL" (e.g., "101INTVL").



### Quick Review/Full Screen Review

Quick review and full screen review are not available during interval timer shooting.



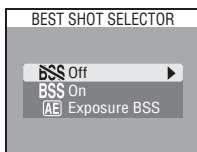

## Best Shot Selector (BSS)

The options in the “best-shot selector” (BSS) menu are recommended for situations in which inadvertent camera movement can produce blurred pictures, or when parts of the image are prone to under- or over-exposure.



Option	Description
<b>BSS Off</b>	BSS off. 
<b>BSS On</b>	Camera takes shots while shutter-release button is pressed, to a maximum of ten. These images are then compared and sharpest picture (picture with highest level of detail) saved to memory card. Flash turns off automatically and focus, exposure, and auto white balance for all photos are determined by the first picture in each series. Recommended for situations in which inadvertent camera movement can produce blurred pictures, for example when: <ul style="list-style-type: none"> <li>• the camera is zoomed in</li> <li>• macro close-up is in effect</li> <li>• lighting is poor and the flash can not be used</li> </ul> 
<b>(AE) Exposure BSS</b>	Selecting this option displays sub-menu shown at right. Choose from: <ul style="list-style-type: none"> <li>• <b>Highlight BSS</b>: picture with smallest area of overexposure is selected.</li> <li>• <b>Shadow BSS</b>: picture with smallest area of underexposure is selected.</li> <li>• <b>Histogram BSS</b>: of pictures with least under- and over-exposure, camera chooses picture with overall exposure closest to optimum. Camera takes five shots each time shutter-release button is pressed. These images are then compared and picture that best meets selected criterion saved to memory card. Flash turns off automatically and focus and auto white balance for all photos are determined by the first picture in each series. Recommended for subjects containing areas of high contrast, when it is difficult to set exposure correctly.</li> </ul> 

 **Restrictions on BSS**

BSS may not produce the desired results with a moving subject or if the composition is changed while the shutter-release button is pressed all the way down. BSS can not be used with the self timer ( 38), **Continuous** ( 80) settings other than **Single**, autoexposure or white-balance bracketing ( 99), or noise reduction ( 101). Image-quality settings of RAW and HI are not available with exposure BSS.

 **BSS**

At settings other than **Off**, the current BSS setting is indicated by an icon in the shooting display.

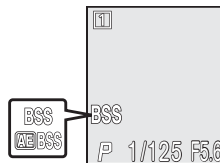

## Image Adjustment

The options in the image adjustment menu control contrast.



Option	Description
<b>A Auto</b>	Camera automatically adjusts contrast according to shooting conditions.
<input type="radio"/> <b>Normal</b>	Camera performs same standard contrast adjustment on all pictures. Suitable for a wide variety of scenes, from dark to bright.
<input checked="" type="radio"/> <b>+ More contrast</b>	Picture processed to emphasize difference between light and dark areas, enhancing contrast. Useful when shooting under overcast skies or shooting low contrast subjects such as landscapes.
<input checked="" type="radio"/> <b>- Less contrast</b>	Picture processed to decrease difference between light and dark areas, reducing contrast. Recommended when light is very bright, creating strong shadows on subject.

### Image Adjustment



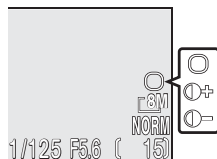

At settings other than **Auto**, the current image-adjustment setting is indicated by an icon in the shooting display. No image adjustment icon is displayed when **Black&white** is selected for **Saturation control**.

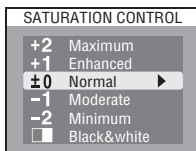

## Saturation Control

Saturation control is used to heighten or reduce the vividness of colors.



Option	Description
<b>+2 Maximum</b>	Use for vivid, photoprint effect when taking pictures that will be printed “as is,” without further modification.
<b>+1 Enhanced</b>	Use for vibrant, photoprint effect when taking pictures that will be printed “as is,” without further modification.
<b>±0 Normal</b>	Recommended for most situations.
<b>-1 Moderate</b>	Use when taking pictures that will later be retouched on a computer.
<b>-2 Minimum</b>	Use when taking pictures that will later be retouched on a computer.
 <b>Black&amp;white</b>	Pictures recorded in black-and-white. Black-and-white images require same amount of memory as color images, but show a higher level of detail. <b>Black&amp;white</b> can not be used in combination with digital zoom (  16), white balance (  76), white-balance bracketing (  99), or RAW image quality (  30).

### Saturation Control

If **Black&white** is in effect when **Sepia movie 320** is selected in the movie menu ( 49), **Saturation control** will be reset to **Normal**.

### Black-and-White

When **Black&white** is selected, monitor shows the view through the lens in black-and-white and a  icon is appears in the shooting display.

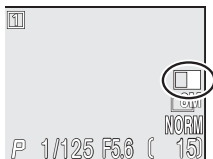

## User Setting

The **User Setting** menu can be used in place of the **FUNC** button to choose the shooting mode. Choose from **Auto** (📷), **Scene** (scene mode), **Custom 1** (shooting mode 1), and **Custom 2** (shooting mode 2). The camera stores changes to settings in shooting modes 1 and 2 and restores these settings the next time the mode is selected, making it possible to create two sets of “custom” settings (one for shooting mode 1 and another for shooting mode 2) and recall them as desired. For more information on shooting modes, see page 15.

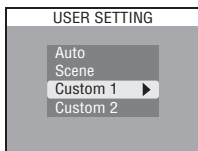

### Displaying the User Setting Menu in 📷 (Auto) Mode

Press the **MENU** button. The menu shown in Step 1 will be displayed.

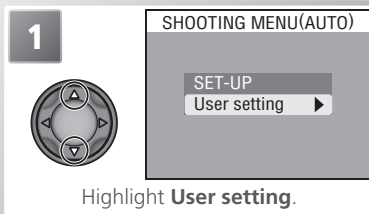

Highlight **User setting**.

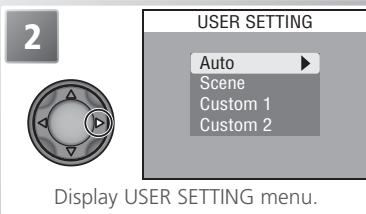

Display USER SETTING menu.

### Displaying the User Setting Menu in Scene Mode

Press the **MENU** button. The menu shown in Step 1 will be displayed.

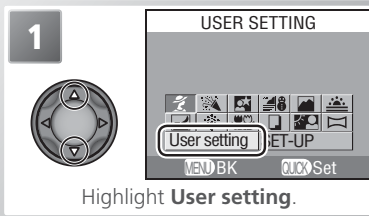

Highlight **User setting**.

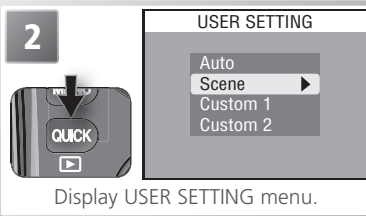

Display USER SETTING menu.

### Shooting Mode

The current shooting mode is shown in the top left corner of the shooting display.



## Image Sharpening

In shooting modes **1** and **2**, the image-sharpening menu controls the amount of sharpening performed. The camera automatically processes pictures to emphasize the borders between light and dark areas, making edges seem sharper. As this processing occurs after shooting, its effects can not be previewed in the shooting display, but they will be visible in the final picture.

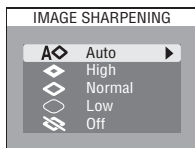



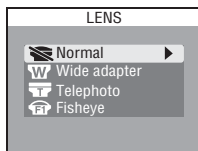

Option	Description
<b>A Auto</b>	Camera sharpens edges for optimal results; amount of sharpening varies from shot to shot.
<b>High</b>	Pictures processed to increase sharpness, making edges more distinct.
<b>Normal</b>	Camera performs same standard level of sharpening on all images.
<b>Low</b>	Sharpening reduced below normal level.
<b>Off</b>	No sharpening performed.

## Lens

The lens menu is used to adjust camera settings for optimal results with the optional converter lenses and adapters listed below. Note that these accessories can only be used with a lens adapter ring (📷 137). For complete information on use and handling, see the documentation provided with each converter lens.



Option	Description
 <b>Normal</b>	No modifications are made to settings. Use when no converter lens is attached (be sure to remove lens adapter ring).
 <b>Wide adapter</b> (for WC-E80)	Camera zooms out to widest angle. Zoom can be adjusted between middle optical zoom position and widest angle.
 <b>Telephoto</b> (for TC-E15ED)	Optical zoom set to maximum optical zoom position. Digital zoom can be used.
 <b>Fisheye</b> (for FC-E9)	<ul style="list-style-type: none"> <li>• Zoom fixed at widest angle.</li> <li>• Focus fixed at infinity.</li> <li>• Metering fixed at center-weighted (📷 79).</li> <li>• Corners of frame blacked out to create circular frame.</li> </ul>

### Using a Flash

The built-in Speedlight turns off automatically at settings other than **Normal**. Optional Speedlights mounted on the accessory shoe (📷 96) can be used with wide-angle and telephoto converter lenses when the optional Speedlight is set to mode A (non-TTL auto). Use of an optional Speedlight is not recommended with fisheye converter lenses, as the flash will be unable to light the entire subject.

### Use Autofocus

When shooting at settings other than **Normal**, use autofocus (📷 37). Manual focus and infinity will not produce results that accurately reflect the selected focus distance.

### Lens

At settings other than **Normal**, the current lens setting is indicated by an icon in the monitor.

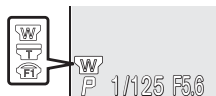



## Exposure Options

The exposure options menu contains two options for controlling exposure.

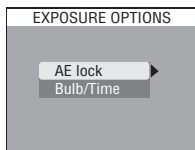

## AE Lock

Autoexposure (AE) lock produces a series of pictures with the same exposure and white balance. This can be used when taking photographs that will later be joined into a single image after transfer to a computer (e.g., a 360° virtual-reality image).

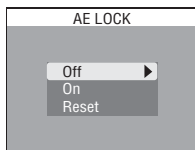

Option	Description
<b>Off</b>	Restores normal exposure and white balance.
<b>On</b>	First picture taken after <b>On</b> is selected sets exposure (shutter speed, aperture, and sensitivity) and white balance for all subsequent pictures. Flash turns off while AE lock is in effect.
<b>Reset</b>	Clears existing exposure settings. First picture taken after this option is selected sets exposure (shutter speed, aperture, and sensitivity) and white balance for all subsequent pictures.

## AE Lock

While AE lock is in effect, an **AE-L** (autoexposure lock) icon appears in the shooting display. After you select **On** or **Reset**, this icon turns yellow to indicate that exposure will be locked with the next shot. The icon will turn white once you have taken a picture to set exposure.



## Bulb/Time

In mode **M** (manual exposure mode), shutter speed can be set to BULB or TIME for long exposures of up to ten minutes (🔧 45). This menu controls how long exposures are made.

### Long Exposures

Longer exposure times increase the amount of noise visible in the picture; we recommend that noise reduction (🔧 101) be turned on for long exposures.





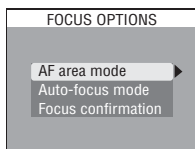

Option	Description
<b>Bulb release</b>	Shutter will remain open as long as shutter-release button is held down, to a maximum of ten minutes.
<b>Timed release</b>	Selecting this option displays menu of exposure times. Choose from <b>30s</b> (thirty seconds), <b>1m</b> (one minute), <b>3m</b> (three minutes), <b>5m</b> (five minutes), or <b>10m</b> (ten minutes). Shutter will open when shutter-release button is pressed and will remain open until specified exposure time has elapsed or the shutter-release button is pressed again. <div data-bbox="730 581 951 735" style="float: right; border: 1px solid black; padding: 5px; margin-top: 10px;">             TIMED RELEASE              Shutter opens for:              30s              1m              3m              5m              10m           </div>

## Focus Options



The focus options menu contains three options controlling focus settings.

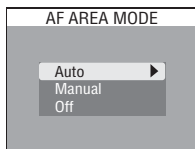

## AF Area Mode

In  (auto) mode, the camera focuses on the subject in the center of the frame. In shooting modes  and  (and in some scene modes;  24–27), five focus areas are available, making it possible to focus on off-center subjects without using focus lock.



Option	Description
<b>Auto</b>	Camera automatically selects focus area containing subject closest to camera. Selected focus area is displayed in red when shutter-release button is pressed halfway. Choose this setting to minimize risk of pictures being out of focus when subject is moving erratically or in other situations in which there is little time to check focus.
<b>Manual</b>	Five focus areas are shown in shooting display; press multi selector up, right, left, or down to select focus area containing subject. Can be used instead of focus lock (  20) to focus on relatively motionless subjects that are not centered in frame; when used with focus lock, can be used to focus on subjects that would not fall in focus area in final composition.
<b>Off</b>	Camera focuses on subject in center focus area. No focus area indicators appear in shooting display. Use focus lock (  20) to focus on off-center subjects.

## Digital Zoom

Focus area selection is not available with digital zoom ( 16). The center focus area is used while digital zoom is in effect.

## Spot AF Area Metering

Focus area selection (both **Auto** and **Manual**) can be used in combination with spot AF-area metering to meter exposure only in the active focus area ( 79).

## Auto-Focus Mode

**Auto-focus mode** determines how the camera focuses. The option selected also applies when shooting movies.

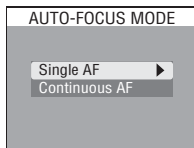

Option	Description
<b>Single AF</b>	Camera focuses when shutter-release button is pressed halfway. Focus locks while shutter-release button is held in this position. Note that pictures can be taken even if camera is not in focus; check focus indicator before shooting.
<b>Continuous AF</b>	Camera adjusts focus continuously until shutter-release button is pressed halfway, minimizing time needed to focus before picture is taken. Focus locks while shutter-release button is pressed halfway. Note that pictures can be taken even when camera is not in focus; check focus indicator lamp before shooting.

## Focus Confirmation

Use focus confirmation to determine exactly what areas of the frame are in focus before a picture is taken. Focus confirmation affects only the view through the lens shown in the shooting display; no indicators of focus appear in the final picture.

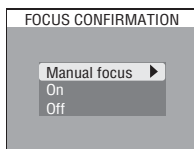



Option	Description
<b>Manual focus</b>	Areas of the image that are in focus will be sharply outlined in shooting display in manual focus mode (47).
<b>On</b>	Areas of the image that are in focus will be sharply outlined in shooting display in all focus modes.
<b>Off</b>	No indication of focus appears in shooting display.

## Zoom Options

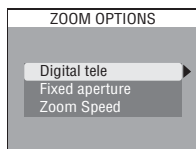
The zoom options menu contains options for digital and optical zoom.





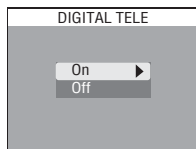

### Digital Tele

When **On** is selected, pressing the  button for about two seconds at the maximum optical zoom position activates digital zoom. When digital zoom is in effect, the camera focuses on the center focus area and center-weighted metering is used. Select **Off** to disable digital zoom in shooting modes  and  except when recording movies.



### Digital Zoom

Digital zoom is not available with **RAW** or **HI** image quality () 30), **Continuous** settings of **Multi-shot 16** or **Ultra HS** () 80), a **Saturation control** setting of **Black&white** () 87), or **Lens** settings of **Wide adapter** or **Fisheye** (

### Fixed Aperture

Controls whether aperture varies with zoom position.

Option	Description
<b>On</b>	In <b>A</b> and <b>M</b> modes, aperture is kept as close as possible to selected f/-number. To prevent selected f/-number from exceeding exposure range at new zoom position, choose aperture of around f/5 to f/8.
<b>Off</b>	Aperture changes with zoom position.

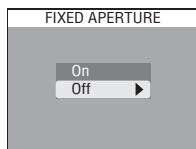

### Zoom Speed

Controls zoom speed.

Option	Description
<b>High</b>	High-speed zoom.
<b>Low</b>	Zoom starts slowly and gradually gains speed. Use for fine adjustments to zoom position.

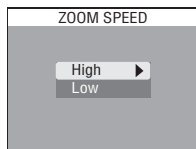

## Speedlight Options

The **Speedlight opt.** menu contains three options for controlling the built-in Speedlight and optional flash units mounted on the camera accessory shoe.

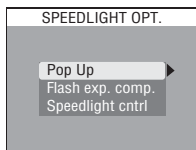

### Pop Up

Controls whether the built-in Speedlight pops up automatically when required.

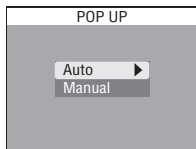

Option	Description
<b>Auto</b>	When shutter-release button is pressed halfway Built-in Speedlight pops up automatically as required and fires when shutter-release button is pressed all the way down. Once raised, Speedlight will only fire when required.
<b>Manual</b>	Built-in Speedlight pops up when  button is pressed, and fires whenever shutter is released.

### Flash Exp. Comp

Use this option to adjust flash output by  $-2.0\text{EV}$  to  $+2.0\text{EV}$  in increments of  $\frac{1}{3}\text{EV}$ .

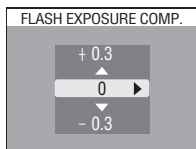

### Lens Hoods

Remove lens hoods (available separately;  137) when using the flash.

### The Accessory Shoe

The camera is equipped with an accessory shoe, allowing optional Nikon SB-series 800, 600, 80DX, 50DX, 30, 28, 28DX, 26, 25, 24, and 22s Speedlights to be mounted directly on the camera without a sync cable. The accessory shoe is equipped with a safety lock for Speedlights with a locking pin, including SB-series 800, 600, 30, 28, 28DX, 26, 25, and 22s Speedlights. Remove the accessory shoe cover before attaching a Speedlight, and replace the cover when the accessory shoe is not in use.

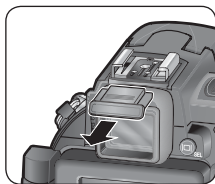

## Speedlight Cntrl





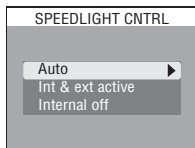











This option is used to control the built-in and optional Speedlights when using optional flash accessories mounted on the camera's accessory shoe.

Option	Description
<b>Auto</b>	Optional Speedlight fires, if attached. If not, built-in Speedlight fires instead.
<b>Int &amp; ext active</b>	Both optional and built-in Speedlights fire.
<b>Internal off</b>	Built-in Speedlight turns off.





### Flash Mode Indicators for Optional Speedlights

When **Internal off** or **Auto** is selected for **Speedlight cntrl** and an optional Speedlight is mounted on the camera, flash mode is indicated as shown below. Note that the camera will not detect optional flash units if the flash-ready lamp on the optional Speedlight is off. Be sure the flash ready lamp is on before taking a picture.

Flash mode (Pop up set to Auto)	Control panel	Shooting display	Flash mode (Pop up set to Manual)	Control panel	Shooting display
Auto			Anytime Flash (fill flash)		
Flash Cancel (off)			Fill flash + red-eye reduction		
Auto with red-eye reduction			Fill flash + slow sync		
Anytime Flash (fill flash)			Slow sync		

 **Using Optional Speedlights**

Refer to the Speedlight manual for detailed instructions. Set the Speedlight flash mode to TTL before shooting. At this setting, the optional Speedlight will be controlled by the camera in response to flash mode  34) and **Speedlight opt.**  96) settings. When the flash fires, the amount of light produced by the optional Speedlight is measured by the camera's photocell, and the length of the flash adjusted to ensure optimal exposure. Note that the camera's photocell, which is part of the built-in Speedlight pop-up unit, controls flash level even when the built-in Speedlight is off; be sure not to block the photocell. If **Manual** is selected for **Pop up**, press the  button to raise the built-in Speedlight before shooting.

When set to STBY (standby), the optional Speedlight will power on at the same time as the camera. The camera does not support AF-assist illumination or red-eye reduction by means of the Speedlight AF-assist function or red-eye reduction lamp. Power zoom is not supported; adjust the zoom angle manually. When a WC-E80 is used with the camera zoomed all the way out, the combined focal length is 28 mm (35-mm format equivalent). Use a wide panel for an illuminating angle wider than 28 mm.







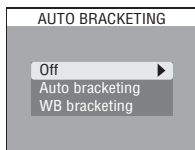

## Auto Bracketing







In some situations, you may find it difficult to select appropriate exposure-compensation and white-balance settings, and yet not have time to check the results and adjust settings after each shot. Auto bracketing can be used to vary these settings automatically over a series of pictures, “bracketing” a selected exposure-compensation or white-balance setting.



Option	Description
<b>Off</b>	Restores normal exposure and white balance.
<b>Auto bracketing</b>	Camera varies exposure with each shot, bracketing current exposure compensation value (autoexposure bracketing;  100).
<b>WB bracketing</b>	Camera takes three shots each time shutter-release button is fully pressed, bracketing current white balance setting to produce one picture with normal white balance, one picture with reddish cast, and one picture with bluish cast. Recording time roughly triples. Use when unsure of appropriate value for white balance.

### Restrictions on Auto Bracketing

Autoexposure bracketing can not be used in combination with a shutter speed of BULB or TIME ( 45), BSS ( 84), exposure BSS ( 84), AE lock ( 20), noise reduction ( 101), or **Continuous** settings of **Multi-shot 16**, **Ultra HS**, **5 shot buffer**, **Time lapse**, or **Movie** ( 80).

White balance bracketing can not be used in combination with BSS ( 84), exposure BSS ( 84), AE lock ( 20), noise reduction ( 101), an image quality of RAW or HI ( 30), **Black&white** ( 87), or **Continuous** settings other than **Single** ( 80).



### Auto Bracketing

When autoexposure bracketing is in effect, a **BKT** icon is displayed in the monitor with the selected exposure increment.

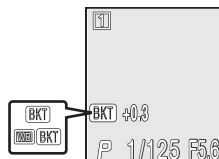
When white balance bracketing is in effect, **WB BKT** icon appears in the monitor.



## Autoexposure Bracketing

When **Auto bracketing** is selected, exposure varies with each shot; the number of shots and amount of exposure compensation performed are selected from the sub-menu shown at right. Values are added to the exposure compensation value selected with the  button ( 39). Bracketing is performed by varying shutter speed (exposure mode **A** and **M**), aperture (exposure mode **S**), or shutter speed and aperture (exposure mode **P**).



AUTO BRACKETING	
3	±0.3 ▶
3	±0.7
3	±1.0
5	±0.3
5	±0.7
5	±1.0

Option	No. of shots	Exposure increment	Bracketing order
<b>3, ±0.3</b>	3	± $\frac{1}{3}$ EV	0, +0.3, -0.3
<b>3, ±0.7</b>	3	± $\frac{2}{3}$ EV	0, +0.7, -0.7
<b>3, ±1.0</b>	3	±1 EV	0, +1.0, -1.0
<b>5, ±0.3</b>	5	± $\frac{1}{3}$ EV	0, +0.7, +0.3, -0.3, -0.7
<b>5, ±0.7</b>	5	± $\frac{2}{3}$ EV	0, +1.3, +0.7, -0.7, -1.3
<b>5, ±1.0</b>	5	±1 EV	0, +2.0, +1.0, -1.0, -2.0

### Continuous Shooting (Autoexposure Bracketing)

At settings of **Continuous H** and **Continuous L** ( 80), shooting will pause after each bracketing cycle is complete. When **Single** is selected, shutter-release button must be pressed once for each shot in bracketing cycle.

### Auto Flash and Auto ISO (Autoexposure Bracketing)

In auto flash mode ( 34), the flash setting for the first shot in each bracketing cycle applies to the remaining pictures. If the flash fires on the first shot, it will fire for the remaining shots; if the flash does not fire on the first shot, it will not fire for the remaining shots. If sensitivity (ISO equivalency) is set to **AUTO** ( 46) in **S**, **A**, or **M** mode, the sensitivity value for the first shot in each bracketing cycle will also apply to the remaining pictures (in **P** mode, sensitivity will vary with each shot).



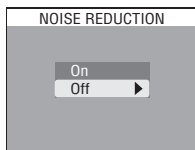

## Noise Reduction

At slow shutter speeds, “noise” in the form of randomly-spaced, brightly-colored pixels may appear in pictures, particularly in shadows. Noise reduction can be used to reduce noise at shutter speeds of  $\frac{1}{4}$  s or slower.



Option	Description
<b>On</b>	Noise reduction takes effect at shutter speeds of about $\frac{1}{4}$ s or slower. Time required to save pictures to memory card more than doubles.
<b>Off</b>	Noise reduction off; camera functions normally.

### Restrictions on Noise Reduction

Noise reduction can not be used in combination with BSS  84), exposure BSS  84), exposure or white-balance bracketing  99), or at **Continuous** settings other than **Single** .

### Sensitivity (ISO Equivalency)

Noise reduction will reduce the noise that occurs at higher sensitivities  46), but only in pictures taken at shutter speeds of  $\frac{1}{4}$  s or slower.

### Noise Reduction

When noise reduction is on, an **NR** icon appears in the shooting display.

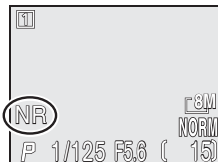

## Reset

Select this option to restore settings for the current shooting mode (mode **1** or **2**) to their original state.

Option	Description
No	Exit menu, leaving settings unchanged.
Reset	Restore settings to default values.

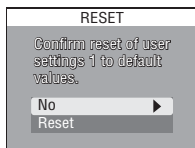

Choosing **Reset** restores the following options for the current shooting mode (Custom1 or Custom 2) to their default values. Changes to settings made in the remaining mode are unaffected.

Basic settings	Default
Flash mode	Auto
Focus mode	Autofocus
Exposure comp.	0.0
Image quality	NORMAL
Image size	<b>8M</b> (3264 × 2448)
Sensitivity	AUTO

Menu options	Default
White balance	Auto*
Metering	Matrix
Continuous	Single
BSS	Off
Image adjustment	Auto
Saturation control	Normal
Image sharpening	Auto
Lens	Normal

\* Fine-tuning reset to 0.

Menu options	Default
Exposure options	
AE lock	Off
Bulb/time	Bulb release
Focus options	
AF area mode	Auto
Auto-focus mode	Single AF
Focus confirmation	MF
Zoom options	
Digital tele	On
Fixed aperture	Off
Zoom speed	High
Speedlight options	
Pop up	Auto
Flash exp. comp.	0.0
Speedlight cntrl	Auto
Auto bracketing	Off
Noise reduction	Off

## My Menu

This option determines which of the nineteen items in the full shooting menu appear in the five-item custom menu displayed when the  button is pressed in shooting modes **1** and **2**. At default settings, the custom menu contains white balance, metering, continuous, BSS, and User Setting options. To change the items displayed in the custom menu:

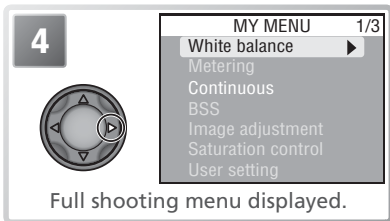
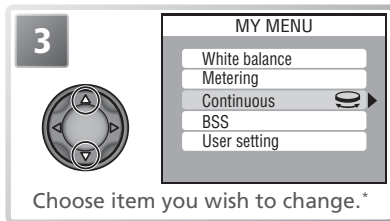
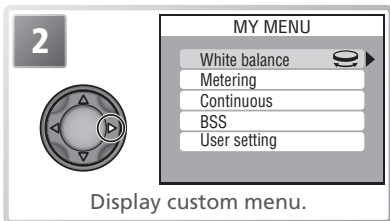
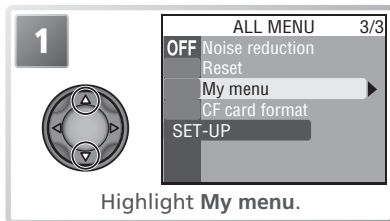
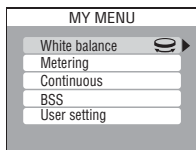

\* Selection can also be made by highlighting items and rotating command dial. Press  button to save changes to menu and return to shooting mode.

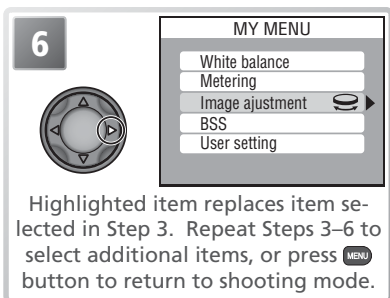
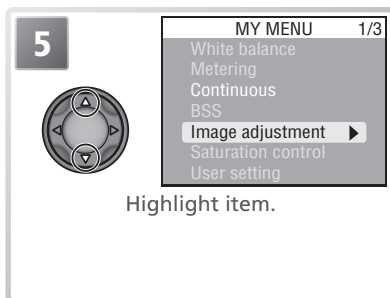

## CF Card Format

**CF card format** formats memory cards for use in the camera. *Note that formatting memory cards permanently deletes all data they contain, including protected pictures and any other data that may be on the card.* Before formatting, be sure to transfer any valued pictures to a computer (📁 65–67).



Option	Description
No	Exit without formatting memory card.
Format	Format memory card. Message shown at right displayed while formatting is in progress. <i>Do not turn the camera off, remove the battery or memory card, or unplug the AC adapter (available separately) while this message is displayed.</i>

FORMATTING...

# The Playback Menu

The playback menu contains the following options:

PLAYBACK MENU 1/2	
Delete	
Folders	
Slide show	
Protect	
Hide image	
Print set	
Auto transfer	

PLAYBACK MENU 1/2		👁
Delete	106–107	
Folders	108–111	
Slide show	112–113	
Protect	114	
Hide image	115	
Print set	116–117	
Auto transfer	118–119	

PLAYBACK MENU 2/2	
Move image	
CF card format	
Small pic	
SET-UP	

PLAYBACK MENU 2/2		👁
Move image	120–121	
CF card format	104, 121	
Small pic	121	
SET-UP	122–136	

To display the playback menu:

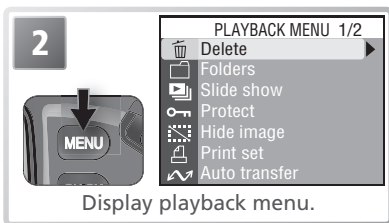

## Delete

The delete menu contains the following options:

Option	Description
<b>Selected images</b>	Delete selected pictures.
<b>Erase all images</b>	Delete all pictures.



### Deleting Selected Pictures

- Highlight **Selected images**.
- Display selection dialog.
- Scroll through pictures. Current picture displayed at bottom of screen.
- Select current picture. Selected pictures marked by icon.
- Repeat steps 3–4 to select additional pictures. To deselect picture, select and press multi selector up or down. To exit without changing selection, press **MENU** button.
- Confirmation dialog displayed. Press multi selector up or down to highlight option, press to right to select:

  - Select **Yes** to delete selected pictures
  - Select **No** to exit without deleting pictures

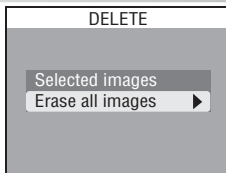

## Deleting All Pictures

**1**Highlight **Erase all images**.**2**

Confirmation dialog displayed. Press multi selector up or down to highlight option, press to right to select:

- Select **Yes** to delete all pictures that are neither hidden nor protected
- Select **No** to exit without deleting pictures

### Before Deletion

Once deleted, pictures can not be recovered. If desired, transfer pictures to a computer before deletion ( 65).

### Protected Pictures

Pictures marked with a  icon are protected and can not be deleted ( 114).

### Hidden Pictures

Pictures hidden with the Hide image option ( 115) are not displayed in the **Delete > Selected images** menu and can not be deleted.

## Folders

By default, pictures are stored in a folder with the name NIKON. To make it easier to locate pictures during playback, additional folders can be created to organize pictures by theme. The playback **Folders** menu is used to create and manage folders, and to select the folder from which pictures will be played back.

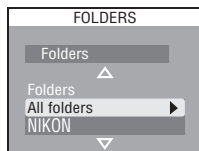

## Folder Options

Selecting **Folders** in the playback **Folders** menu displays the following options:

Option	Description
<b>New</b>	Create new folders.
<b>Rename</b>	Rename existing folders.
<b>Delete</b>	Delete folders and all items they contain.

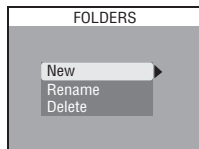

## Creating New Folders

**1**

Highlight **New**.

**2**

Display new folder dialog.

**3**

Highlight letter.

**4**

Edit letter.\*

\* Folder names can include upper case letters ("A"–"Z"), numbers, and spaces.

- 5** Repeat steps 3 and 4 to create new five-letter folder name. Press  button to exit without creating folder.

- 6** Highlight last letter and press multi-selector to right to complete operation and exit to playback menu.

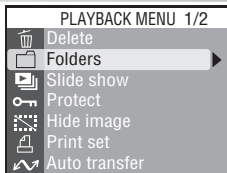

Highlight last letter and press multi-selector to right to complete operation and exit to playback menu.

## Renaming Existing Folders

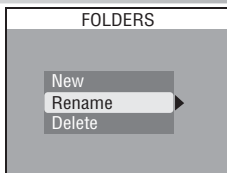
**1**

Highlight **Rename**.

**2**

Display list of existing folders.\*

\* Folder NIKON can not be renamed.

**3**

Highlight folder name.

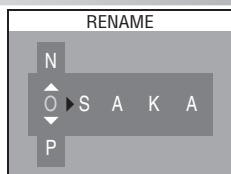
**4**





Select folder.

- 5** Edit name as described in steps 3–6 of “Creating New Folders.”

## Folder Options

The **Folders** menu can also be accessed from the setup menu ( 122).

## Deleting Folders



<p><b>1</b></p> 	<p>FOLDERS</p> <p>New Rename Delete</p>	<p>Highlight <b>Delete</b>.</p>
<p>* Folder NIKON can not be deleted.</p>		
<p><b>2</b></p> 	<p>DELETE</p> <p>OSAKA TOKYO KOBE</p>	<p>Display list of existing folders.*</p>
<p><b>3</b></p> 	<p>DELETE</p> <p>OSAKA TOKYO KOBE</p>	<p>Highlight folder name.</p>
<p><b>4</b></p> 	<p>DELETE</p> <p>Delete : OSAKA</p> <p>Confirm folder deletion?</p> <p>No Yes</p>	<p>Confirmation dialog displayed. Press multi selector up or down to highlight option, press right to select.</p> <ul style="list-style-type: none"> <li>• Select <b>No</b> to exit without deleting folder</li> <li>• Select <b>Yes</b> to delete selected folder</li> </ul>

### Hidden and Protected Pictures

If the selected folder contains hidden or protected pictures, the folder will not be deleted. Note, however, that any pictures it contains that are neither hidden nor protected *will* be deleted.

## Choosing a Folder for Playback

The **Folders** item in the playback menu can be used to select all folders for playback, or to view pictures in a selected folder.

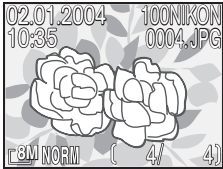
<p><b>1</b></p> 	<p>FOLDERS</p> <p>Folders</p> <p>Folders</p> <p>All folders</p> <p>NIKON</p>	<p><b>2</b></p> 	<p>PLAYBACK MENU 1/2</p> <p>Delete</p> <p>Folders</p> <p>Slide show</p> <p>Protect</p> <p>Hide image</p> <p>Print set</p> <p>Auto transfer</p>
<p>Highlight folder. To view pictures in all folders, highlight <b>All folders</b>.</p>		<p>Select folder and return to playback menu.</p>	
<p><b>3</b></p> 		<p>Return to playback. Most recent picture in current folder is displayed.</p>	

The chosen folder will be used for playback until a new folder is selected.

### Panorama Assist/Ultra HS/Time lapse

Each series of pictures taken at the above settings is stored in its own folder. To view only the pictures in a selected series, choose the appropriate folder from the **Folders** menu. To delete all pictures in a selected series, select the appropriate folder in the **Folders>Folders>Delete** menu. Note that folders created at these settings can not be used to store additional pictures; any pictures taken while one of these folders is selected for playback will be stored in the default location.

## Slide Show

This option is used to play back the pictures in the current folder an automated “slide show.” Hidden pictures are not played back.

Option	Description
<b>Start</b>	Start slide show.
<b>Frame intvl</b>	Choose how long each picture is displayed.
<b>Loop</b>	If this option is checked, slide show will repeat until <b>QUICK</b> button is pressed.

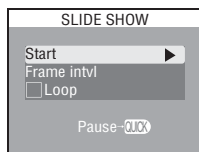

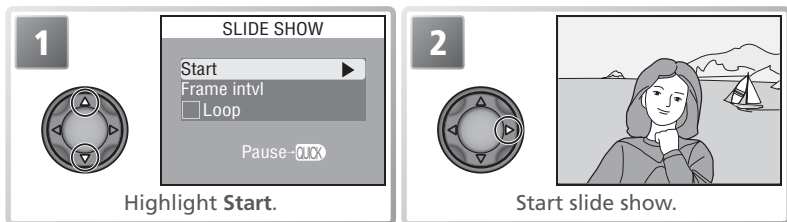

To view a slide show:

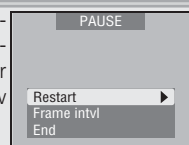

Pictures will be played back one after the other in the order recorded, with a pause between each frame. Movies are displayed as still images showing the movie's first frame. The following operations can be performed:

To	Press	Description
Pause slide show	<b>QUICK</b>	Menu shown at right will be displayed. To resume slide show, highlight <b>Restart</b> and press multi selector to right. Select <b>End</b> to end slide show and return to full-frame playback.
Go forward or back one frame		Press multi selector up or left to go back one frame, down or right to skip ahead to next frame.
End slide show	<b>MENU</b>	End slide show and return to full-frame playback.



When the slide show ends, the pause menu will be displayed ( 112). Press the multi selector to the left to return to the playback menu, or press the  button to exit to full-frame playback.

### *Changing the Display Interval*

The slide show menu on the previous page and the pause dialog shown above contain a **Frame intvl** option for choosing how long each picture will be displayed. To change the display interval, highlight **Frame intvl** and press the multi selector to the right. The menu of interval settings shown at right will be displayed; highlight the desired setting and press the multi selector to the right.

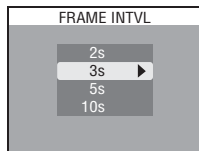
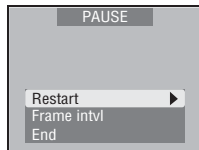

### **Auto Off**

The camera will enter standby mode if no operations are performed for thirty minutes during a slide show.

### **Frame Interval**

Owing to differences in file size and the speed at which pictures can be read from the memory card, the actual interval may differ from the value selected.

## Protect

This option is used to protect pictures from accidental deletion. Protected files can not be deleted by pressing the  button or using the options in the **Delete** menu. Note, however, that protected pictures *will* be deleted when the memory card is formatted.

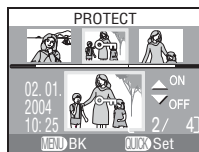

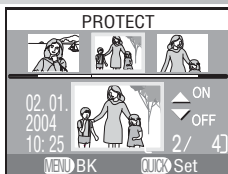

1

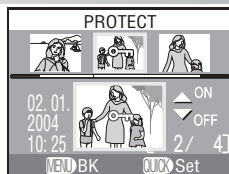

Scroll through pictures. Current picture displayed at bottom of screen.

2



Select current picture. Selected pictures marked by  icon.

3

Repeat steps 1–2 to select additional pictures. To deselect picture, select and press multi selector up or down. To exit without changing selection, press  button.

4

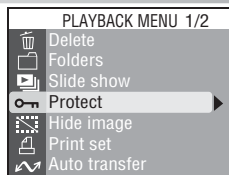

Complete operation.



## Hide Image

When creating a slide show or showing pictures to an audience, the **Hide image** option can be used to hide selected pictures. Hidden pictures are visible only in the **Hide image** menu and can not be deleted with the  button or the delete options in the playback and folder menus. Note, however, that hidden pictures *will* be deleted when the memory card is formatted.



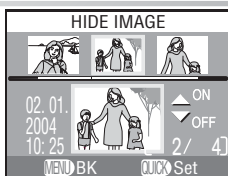

1

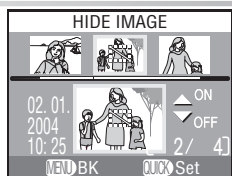

Scroll through pictures. Current picture displayed at bottom of screen.

2



Select current picture. Selected pictures marked by  icon.

3

Repeat steps 1–2 to select additional pictures. To deselect picture, select and press multi selector up or down. To exit without changing selection, press  button.

4

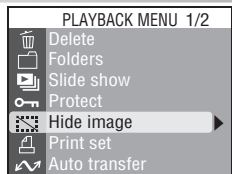

Complete operation.

### "ALL IMAGES ARE HIDDEN"

If all pictures in the current folder are hidden, the message "ALL IMAGES ARE HIDDEN" will be displayed in review and full-frame playback. No pictures can be viewed until another folder has been selected or **Hide image** is used to reveal some of the pictures in the current folder.

## Print Set

**Print set** is used to select pictures for printing on devices that support PictBridge or Digital Print Order Format (DPOF), to choose the number of copies to be printed, and to specify the information to be included with each print. For information on printing the pictures in the print order, see “More on Playback: Printing Pictures” (68).

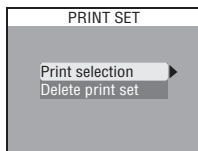

Option	Description
<b>Print selection</b>	Create or modify print order as described below.
<b>Delete print set</b>	Cancel print order. Print marking will be removed from all images, but no pictures will be deleted.

To create a print order or modify the existing print order:

- 1** Highlight **Print selection**.
- 2** Display selection dialog.
- 3** Scroll through pictures. Current picture displayed at bottom of screen.
- 4** Select current picture and set number of prints to 1. Selected pictures marked by icon.

5

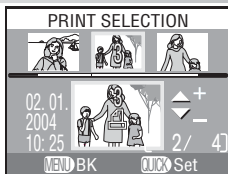

Use multi selector to specify number of prints (up to 9). To deselect picture, press multi selector down when number of prints is 1. Repeat steps 3–5 to select additional pictures. To exit without altering print order, press **MENU** button.

6

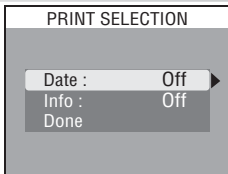

Complete print order and display menu of print options.

- To print date of recording on all pictures in print order, highlight **Date** and press multi selector to right. **ON** will appear next to item.
- To print shutter speed and aperture on all pictures in print order, highlight **Info** and press multi selector to right. **ON** will appear next to item.
- To turn selected item off, highlight and press multi selector to right.

To complete print order and return to playback, highlight **Done** and press multi selector to right. To exit without altering print order, press **MENU** button.

### Print Set

If the menu shown in Step 6 is displayed after a print order is created, the **Date** and **Info** options will be reset.

### "Date"

If **Date** is selected in the print set menu, the date of recording will appear on any pictures printed using devices that support the DPOF date function. Note that the information printed on the image will not be correct unless the camera clock was set correctly when the picture was taken ( 11).

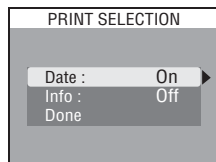

## Auto Transfer

When the camera is connected to a computer running PictureProject, pictures can be transferred (copied) to the computer (65). PictureProject can be used to transfer all pictures or only those pictures selected in advance using **Auto transfer**.

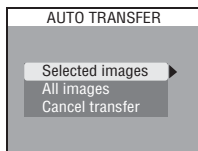

Option	Description
<b>Selected images</b>	Select pictures for transfer.
<b>All images</b>	Mark all pictures for transfer.
<b>Cancel transfer</b>	Remove transfer marking from all pictures.

## Marking Selected Pictures for Transfer

- Highlight **Selected images**.
- Display selection dialog.
- Scroll through pictures. Current picture displayed at bottom of screen.
- Select current picture. Selected pictures marked by icon.
- Repeat steps 3–4 to select additional pictures. To deselect picture, select and press multi selector up or down. To exit without changing selection, press **MENU** button.

**6**

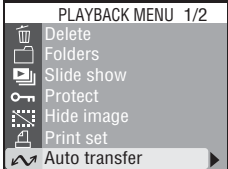
Complete operation.



## Marking All Pictures for Transfer

**1**

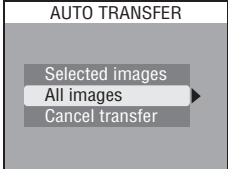
Highlight **All images**.

**2**

Confirmation dialog displayed. Press multi selector up or down to highlight option, press to right to select:

- Select **Yes** to select all pictures for transfer
- Select **No** to exit without selecting pictures for transfer

### Restrictions on Auto Transfer

No more than 999 pictures can be transferred using **Auto transfer**. To transfer more than 999 pictures, use PictureProject to transfer all pictures, or select and transfer pictures in batches of 999 or less.

The COOLPIX 8700 can not be used to transfer pictures selected for transfer with another model of Nikon digital camera. Use the COOLPIX 8700 to reselect the pictures.

## Move Image

To move pictures to another folder on the memory card:

**1** Select source folder.

**2** Display selection dialog.

**3** Scroll through pictures. Current picture displayed at bottom of screen.

**4** Select current picture. Selected pictures marked by icon.

**5** Repeat steps 3–4 to select additional pictures. To deselect picture, select and press multi selector up or down. To exit without changing selection, press **MENU** button.

**6** Display list of destination folders.

### Source/Destination Folders

The following can not be selected as source or destination folders:

- Folders created at **Ultra HS** (folder names begin with "N\_")
- Folders created using **Time lapse** (folder names begin with "INTVL")
- Folders created at a setting of **Panorama assist** (folder names begin with "P\_")

7



SELECT DEST. FOLDER



Highlight destination folder.

8

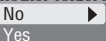

MOVE IMAGE(S)?

Confirm image move  
to another folder?

Confirmation dialog displayed. Press multi selector up or down to highlight option, press to right to select:

- Select **Yes** to move pictures to selected folder
- Select **No** to exit without moving pictures

## CF Card Format

**CF card format** formats memory cards for use in the camera. See “The Shooting Menu: CF Card Format” ( 104).

CF CARD FORMAT

WARNING!  
All images will be  
deleted!

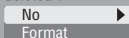

## Small Pic

**Small pic** controls the size of copies created with the small picture option ( 62). Choose from sizes of 640 × 480, 320 × 240, and 160 × 120.

SMALL PIC

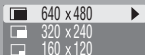

## info.txt

Moving pictures deletes the associated entries from the info.txt file ( 134).

## File Names

When a picture is moved, it will be assigned a new file number generated by adding one to the highest file number in the destination folder. The identifier (DSCN, SSCN, RSCN) and extension (.NEF, .TIF, .JPG, .MOV) will not change.

# The Setup Menu

The setup menu contains the following options:

SET-UP 1/3	
Language	▶
Date	
Folders	
Monitor options	
Seq. numbers	
Shutter sound	
Auto off	

SET-UP 2/3	
CF card format	▶
Controls	
Shot confirmation	
info.txt	
USB	
Video mode	
Reset all	

SET-UP 3/3	
Date imprint	▶
Ver. Firmware version	

SET-UP 1/3		
Language		124
Date		124-125
Folders		126
Monitor options		126-128
Seq. numbers		129
Shutter sound		130
Auto off		131

SET-UP 2/3		
CF card format		104, 131
Controls		132-133
Shot confirmation		133
info.txt		134
USB		134
Video mode		135
Reset all		135

SET-UP 3/3		
Date imprint		136
Firmware version		136

To display the setup menu, press the button to display the menu for the current mode, then follow the steps on the opposite page.



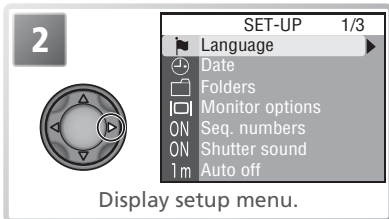
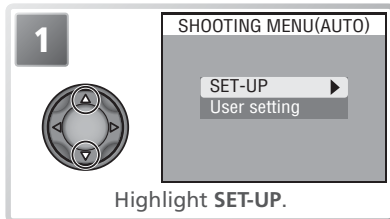
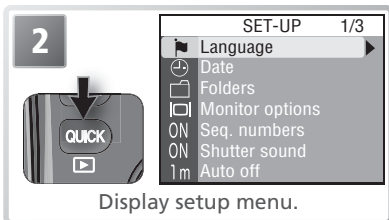
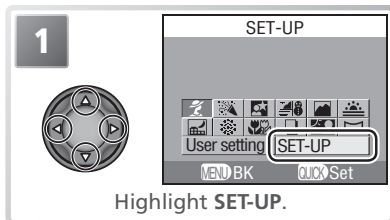
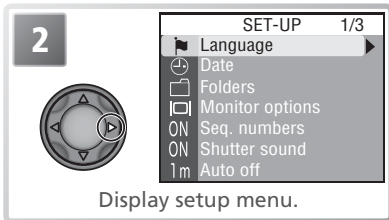
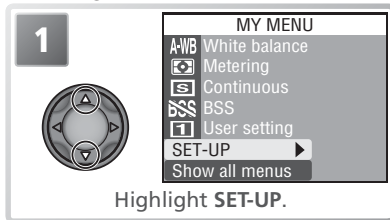
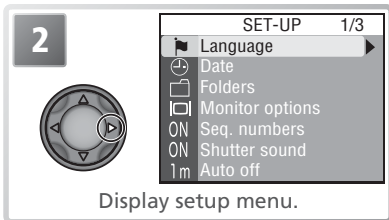
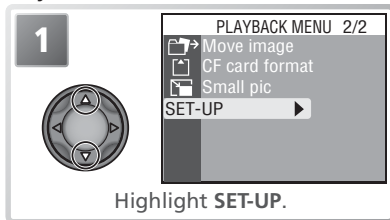

**📷 (Auto) Mode****Scene Mode****Shooting Modes [1] (Custom 1) and [2] (Custom 2)****Playback Mode**

## Language

Choose the language for camera menus and messages from **Deutsch** (German), **English**, **Español** (Spanish), **Français** (French), **Italiano** (Italian), **Nederlands** (Dutch), **Svenska** (Swedish), 日本語 (Japanese), 中文(简体) (Simplified Chinese), and 한글 (Korean).

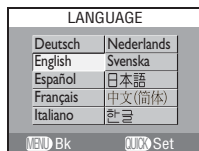

## Date

The date menu contains the following options:

Option	Description
<b>Date</b>	Set camera to current date and time (▶ 11).
<b>Time zone</b>	Choose home and travel destination time zones; turn daylight saving time on or off.

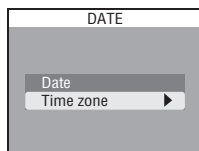

## Choosing Home and Travel Destination Time Zones

Selecting **Time zone** in the **Date** menu displays the menu shown in Step 1.

**1**

TIME ZONE  
02. 01. 2004 11:00  
🏠 London, Casablanca  
Time Zone  
 DaylightSaving  
➔ London, Casablanca  
Time Zone ▶  
 DaylightSaving

Highlight **Time Zone** option for home (🏠) or travel destination (➔).

**2**

NEW CITY TIME ZONE

➔ London, Casablanca ◀▶

MENU Bk      QUICK Set

Display map of world time zones.

**3**

NEW CITY TIME ZONE

➔ Madrid, Paris, Berlin ◀▶

MENU Bk      QUICK Set

Highlight time zone.\*

**4**



TIME ZONE  
02. 01. 2004 12:00  
🏠 London, Casablanca  
Time Zone  
 DaylightSaving  
➔ Madrid, Paris, Berlin ▶  
Time Zone  
 DaylightSaving

Return to time zone menu.

\* Travel destination time zone can not be same as home time zone. To exit without changing selected time zone, press **MENU** button.

To switch between home and travel destination time zones:

**1**

Highlight home (🏠) or travel destination (➔) time zone (dot marks item currently selected).\*

**2**

Select highlighted time zone. Clock set to time in selected zone.

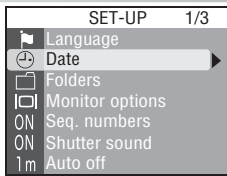
\* To turn daylight saving time on or off, highlight **DaylightSaving** and press multi-selector right. Selecting daylight saving time advances time in selected zone one hour. To exit without changing settings, press **MENU** button.

## Time Zones

The time zone can not be selected if the date and time have not been set.

The camera supports the time zones listed below. Increments of less than one hour are not supported; when travelling to or from destinations at half- or quarter-hour increments from Greenwich Mean Time (GMT), such as Afghanistan, Central Australia, India, Iran, Nepal, or Newfoundland, set the camera clock to local time (🕒 12).

GMT +/-	Location
GMT -11	Midway, Samoa
GMT -10	Hawaii, Tahiti
GMT -9	Alaska, Anchorage
GMT -8	PST (PDT): Los Angeles, Seattle, Vancouver
GMT -7	MST (MDT): Denver, Phoenix, La Paz
GMT -6	CST (CDT): Chicago, Houston, Mexico City
GMT -5	EST (EDT): New York, Toronto, Lima
GMT -4	Caracas, Manaus
GMT -3	Buenos Aires, Sao Paulo
GMT -2	Fernando de Noronha
GMT -1	Azores
GMT	London, Casablanca

GMT +/-	Location
GMT +1	Madrid, Paris, Berlin
GMT +2	Athens, Helsinki
GMT +3	Moscow, Nairobi
GMT +4	Abu Dhabi, Dubai
GMT +5	Islamabad, Karachi
GMT +6	Colombo, Dacca
GMT +7	Bangkok, Jakarta
GMT +8	Beijing, Hong Kong, Singapore
GMT +9	Tokyo, Seoul
GMT +10	Sydney, Guam
GMT +11	New Caledonia
GMT +12	Auckland, Fiji

## Folders

In addition to creating, renaming, and deleting folders (📁 108), the folders option in the setup menu can be used to select the folder in which subsequent pictures will be stored. Press the multi selector up or down to highlight a folder and then press the multi selector to the right to select. Until a new folder is chosen, all new pictures will be stored in the selected folder.

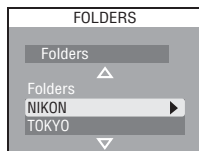

## Monitor Options

The options in this menu control the quality of the preview displayed in the monitor, whether pictures are displayed after shooting (picture review), monitor brightness and hue, and the welcome screen displayed when the camera is turned on.

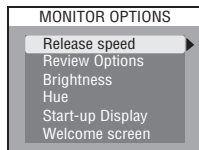

## Release Speed

In shooting modes 1 (Custom 1) and 2 (Custom 2), this option can be used to minimize the delay between the shutter-release button being pressed and the picture being taken, at the cost of a slight drop in the quality of the preview image displayed in the monitor.

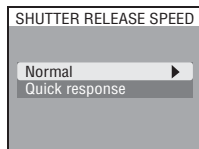



Option	Description
<b>Normal</b>	Priority given to quality of preview image displayed in monitor.
<b>Quick response</b>	Reduces lag between shutter-release button being pressed and shutter being released when shooting stills (movies are not affected). <sup>*</sup> Horizontal lines may appear in preview image; final picture is not affected.

<sup>\*</sup> If a picture is taken during picture review (📁 127), the focus, exposure, and auto white-balance settings used in the previous shot will apply to the new picture. To ensure a quick response, the built-in Speedlight may not fire if a picture is taken during picture review; optional Speedlights may not fire if **Continuous** is set to **Single**.

## 📁 Panorama Assist/Ultra HS/Time lapse

Folders created with the **Panorama assist** (📁 27), **Ultra HS** (📁 80), and **Time lapse** (📁 80) options can not be used to store additional pictures.

## Review Options

This option controls whether pictures are displayed after shooting (picture review) in shooting modes  (Custom 1) and  (Custom 2).

Option	Description
<b>Review On</b>	Pictures are displayed for about one second after shooting.
<b>Review Off</b>	Pictures are not displayed after shooting.

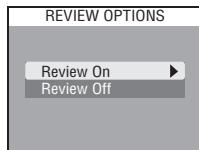

## Brightness

This option controls monitor brightness. Press the multi selector up or down to increase or decrease brightness. The results of any changes are immediately visible in the center of the display. Press the multi selector to the right to put the change into effect and return to the setup menu. To exit without changing monitor brightness, press the multi selector to the left.



## Hue

This option controls monitor hue (tone). The results are visible in the center of the display. Press the multi selector to the right to put the change into effect and return to the setup menu. To exit without changing monitor hue, press the multi selector to the left.



### "Brightness" and "Hue"

These options can not be adjusted while the EG-E5000 A/V cable is connected ( 64); changes to brightness and hue are not reflected in the television display.

## Start-up Display

**Start-up display** controls whether the monitor or the electronic viewfinder lights when the camera is turned on. This option takes effect in shooting modes **1** (Custom 1) and **2** (Custom 2) only; in all other modes, the monitor functions normally. Regardless of the setting chosen, the user can still switch between displays using the **DISP** button when the camera is in shooting mode.

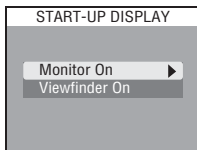

Option	Description
<b>Monitor On</b>	Monitor turns on at startup. Viewfinder turns on automatically if monitor is closed.
<b>Viewfinder On</b>	Viewfinder turns on at startup and when shooting mode is selected after playback.

## Welcome Screen

Choose the welcome screen displayed when the camera is turned on.

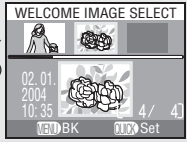

Option	Description
<b>Disable welcome</b>	No welcome screen displayed when camera is turned on.
<b>Nikon</b>	Image shown at right is displayed when camera is turned on. 
<b>Select an image</b>	Choose welcome screen from pictures on memory card. Press multi selector left or right to scroll through pictures, press <b>OK</b> button to select. To exit without changing welcome screen, press <b>MENU</b> button. 

## Seq. Numbers

Pictures are assigned file names that include a four-digit file number assigned by adding one to the largest file number in the current folder. This option controls how file numbers are assigned when a new folder is created, a new memory card is inserted, or the memory card is formatted. For more information on file and folder names, see “Image File and Folder Names” ( 22).

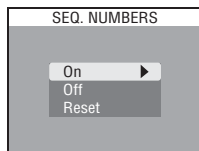

Option	Description
On	When new folder is created, new memory card inserted, or memory card formatted, file numbering continues from last number used. This minimizes number of images with same file name, making it easier to manage images after transfer to computer.
Off	File numbering reset to 0001 when new folder is created, new memory card inserted, or memory card formatted.
Reset	Clears last file number from memory. If memory card is formatted or empty memory card inserted before <b>Reset</b> is selected, file numbering will begin from 0001. If memory card already contains pictures, next file number will be generated by adding one to highest file number in current folder.

## Welcome Screen ( 128)

If **Reset all** ( 135) is used to reset settings to default values, **Welcome screen** will be reset to **Nikon**. If **Select an image** is chosen after settings have been reset, the image last selected for **Select an image** will be restored.

If **Select an image** is chosen after a custom welcome screen has been selected, the confirmation dialog shown at right will be displayed. Select **Yes** to replace the existing picture with the new welcome screen, **No** to exit leaving the welcome screen unchanged.



## Panorama Assist/Time Lapse

At settings of **Panorama Assist** and **Time Lapse**, file numbering starts from 0001 whenever a new folder is created, regardless of the setting chosen for **Seq. Numbers**.

## Shutter Sound

**Shutter sound** controls the “beep” made by the camera speaker.



Option	Description
On	<p><i>Camera beeps once to confirm that:</i></p> <ul style="list-style-type: none"> <li>• power has been turned on</li> <li>• camera has completed preparations for shooting</li> <li>• images have been deleted or memory card formatted</li> <li>• manual focus has been activated or converter lens option selected in <b>Lens</b> menu</li> <li>• changes have been made to image status with <b>Protect</b> or <b>Hide image</b> options in playback menu</li> <li>• <b>Shutter sound</b> has been set to on</li> </ul> <p><i>Camera beeps twice to confirm that:</i></p> <ul style="list-style-type: none"> <li>• shutter-release button has been fully pressed to release shutter (no beep will sound if <b>Release speed</b> is set to <b>Quick response</b>)</li> </ul> <p><i>If camera beeps four times when shutter-release button is pressed:</i></p> <ul style="list-style-type: none"> <li>• memory card is full or not inserted, or</li> <li>• batteries are exhausted</li> </ul>
Off	Confirmation and warning beeps disabled. Voice memos and sound recorded with movies can still be played back.



## Auto Off

When operated on battery power, the camera will enter standby mode if no operations are performed for the length of time selected in the AUTO OFF menu. Choose from thirty seconds (**30s**), one minute (**1m**, the default setting), five minutes (**5m**), or thirty minutes (**30m**). In standby mode, all camera functions are deactivated and the camera itself is effectively off, consuming almost no power. The camera can be reactivated by pressing the , **MENU**, **QUICK**, or **DISP** buttons or by pressing the shutter-release button halfway. Regardless of the option chosen in the AUTO OFF menu, the monitor will remain on for three minutes when menus are displayed. The camera will not enter standby mode while connected to a computer.

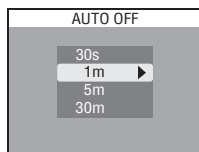

## CF Card Format

**CF card format** formats memory cards for use in the camera. See “The Shooting Menu: CF Card Format” ( 104).



## 2CR5 (DL245) Batteries



When powered by a six-volt 2CR5 (DL245) lithium battery, the camera may become hot if left on for an extended period. We recommend that you set **Auto off** to five minutes or less when using this type of battery.

## Using an AC Adapter

When powered by an optional EH-53 AC adapter, the camera will remain on for thirty minutes if no operations are performed, regardless of the setting chosen in the **Auto off** menu. If the camera is connected to a video device, video output will continue indefinitely after the monitor has turned off.

## Controls

This menu contains the following options:



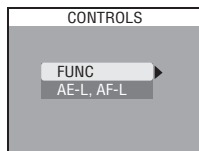





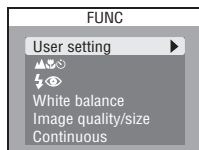









Option	Description
<b>FUNC</b>	Specify function performed by  button.
<b>AE-L, AF-L</b>	Specify function performed by  button.



## FUNC

Assigning frequently-used functions to the  button allows the selected settings to be adjusted one-handed, without accessing the camera menus.





Option	Description
<b>User setting</b>	Shooting mode (  , scene, Custom 1, Custom 2) can be selected by pressing  button and rotating command dial (  15).
 (focus mode)	Focus mode (  37) can be selected by pressing  button. Press  button and rotate command dial to select manual focus distance (  47).
 (flash mode/ sensitivity)	Flash mode (  34) can be selected by pressing  button. Press  button and rotate command dial to set sensitivity (ISO equivalence;  46).
<b>White balance</b>	White balance can be set by pressing  button and rotating command dial when camera is in shooting mode <b>1</b> or <b>2</b> . White balance can not be fine-tuned using  button. Camera will measure new value for preset white balance if  button is kept pressed.
<b>Image quality/size</b>	Image quality can be set by pressing  button. Image size can be set by pressing  button while rotating command dial.
<b>Continuous</b>	<b>Continuous</b> can be set by pressing  button and rotating command dial when camera is in shooting mode <b>1</b> or <b>2</b> .

## AE-L, AF-L

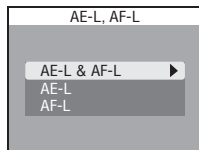
By default, both focus and exposure are locked when the  button is pressed. If desired, the button can be set to lock only one of focus and exposure.



Option	Description
<b>AE-L &amp; AF-L</b>	 button locks both focus and exposure.
<b>AE-L</b>	 button locks exposure only. Focus locks when shutter-release button is pressed halfway.
<b>AF-L</b>	 button locks focus only. Exposure locks when shutter-release button is pressed halfway.

## Shot Confirmation

If **On** is selected for this option, the self-timer lamp will light after shooting to confirm that the shutter has been released. When **Multi-shot 16** is selected for **Continuous**, the lamp will light after all pictures in the series have been taken. The lamp will not light at a setting of **Ultra HS** or if the flash fired when the picture was taken.



## info.txt

When pictures are recorded with **On** selected for **info.txt**, information about each image is added to an independent text file (“info.txt”) stored in the same folder as the picture. When the contents of the memory card are viewed on a computer, this file can be read with a text browser such as Notepad or SimpleText. If

**Off** (the default option) is selected, photo information will no longer be recorded to the info.txt file. Information about pictures recorded when **Off** is selected can still be viewed in the photo information display (📷 58).

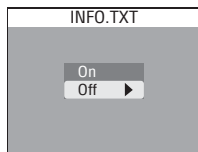

When **On** is selected, the following information is recorded:

- File number and type
- Camera type and firmware version
- Metering mode
- Exposure mode
- Shutter speed
- Aperture
- Exposure compensation
- Focal length and digital zoom factor
- Image adjustment
- Sensitivity (ISO equivalency)
- White balance
- Image sharpening
- Date of recording
- Image size and quality
- Saturation control
- Active focus area

Images are listed in the order recorded, separated by a blank line.

## USB

**USB** configures the camera for connection to a computer or printer. See “Viewing Pictures on a Computer” (📷 65) and “Printing Pictures: Printing Via Direct USB Connection” (📷 69).

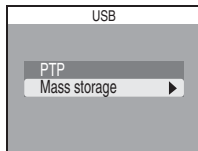

## 📎 info.txt

The info.txt file can not be transferred to a computer using PictureProject. It can be copied using normal Explorer or Finder operations when the camera **USB** option is set to **Mass storage**.

## Video Mode

Before connecting the camera to a video device such as a television or VCR ( 64), choose a video mode setting that matches the video standard used by the device. The camera supports NTSC and PAL standards.

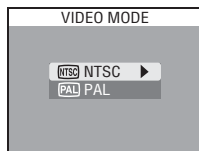

## Reset All

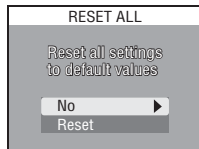

Restore settings to default values.

Option	Description
No	Exit menu, leaving settings unchanged.
Reset	Restore all settings except shooting mode, exposure mode, <b>Language</b> , <b>Date</b> , <b>Video mode</b> , and <b>USB</b> to default values.



## Date Imprint

The date imprint option is used to imprint the date or the date and time of recording on pictures as they are recorded to the memory card. It can not be used to imprint a date stamp on pictures after recording.

Option	Description
 <b>Off</b>	Time and date do not appear on pictures.
 <b>Date</b>	Date is imprinted on pictures taken while this option is in effect.
 <b>Date and time</b>	Date and time are imprinted on pictures taken while this option is in effect.

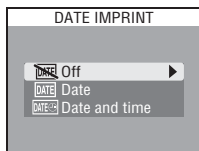



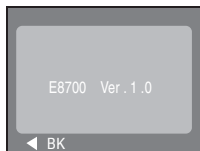

## Firmware Version

Select this option to display the current camera firmware version. Press the multi selector to the left to return to the setup menu.





## Date Imprint

Data imprinted at a size of **T**V (640×480), **P**C (1,024×768), or **1**M (1,280×960) may be difficult to read.

**Date imprint** can not be used with panorama assist ( 27), an image-quality setting of RAW ( 30), **Continuous** settings of **Continuous H**, **Ultra HS**, **5 shot buffer**, or **Movie** ( 80), or exposure BSS ( 84).

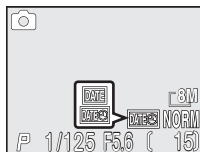
Imprinted data form a permanent part of the image and will appear whenever the image is printed, regardless of whether the date option is chosen in the **Print set** menu. At settings other than **Off**, a date imprint icon appears in the shooting display during shooting. Check before shooting to make sure that the camera clock is set to the correct time and date.



The date is recorded in the order selected in the DATE menu. **Date imprint** can not be selected if the camera clock has not been set ( 11–13).

## Optional Accessories

At the time of writing, the following optional accessories were available for this camera. Contact your local retailer or Nikon representative for details.



<b>Rechargeable batteries/ Battery packs/ Battery chargers/ AC adapters</b>	<ul style="list-style-type: none"><li>• Additional EN-EL1 Li-ion batteries are available from your retailer or local Nikon representative</li><li>• MB-E5700 battery pack</li><li>• MH-53C battery charger (plugs into vehicle cigarette-lighter socket)</li><li>• EH-53 AC adapter</li></ul>
<b>Carrying case</b>	CS-CP11 soft case
<b>PC card adapters</b>	EC-AD1 PC card adapter
<b>Converter lenses (require lens adapter ring)</b>	<ul style="list-style-type: none"><li>• FC-E9 fisheye converter (0.2 ×)</li><li>• WC-E80 wide-angle converter (0.8 ×)</li><li>• TC-E15ED telephoto converter (1.5 ×)</li></ul>
<b>Lens adapter rings</b>	<ul style="list-style-type: none"><li>• UR-E8 lens adapter ring for WC-E80 and TC-E15ED</li><li>• UR-E12 step-down ring lens adapter for FC-E9</li></ul>
<b>Wired remote cable</b>	MC-EU1 remote cord
<b>Lens hoods</b>	<ul style="list-style-type: none"><li>• HR-E5700 lens hood</li><li>• HN-CP11 lens hood</li></ul>
<b>Filters (attach to HN-CP11 lens hood)</b>	77-mm (3") Nikon filters
<b>Optional Speedlights</b>	SB-series 800, 600, 50DX, 30, 22s
<b>Sync cables (for off- camera flash)</b>	<ul style="list-style-type: none"><li>• SC-29</li><li>• SC-28</li></ul>

### Use Only Nikon-Approved Flash Accessories

Use only Nikon Speedlights. Negative voltages or voltages over 250V applied to the accessory shoe could not only prevent normal operation, but could damage the sync circuitry of the camera or flash. Before using a Nikon Speedlight not in the list above, contact a Nikon-authorized service representative for more information.





### **The HN-CP11 and HR-E5700 Lens Hoods**

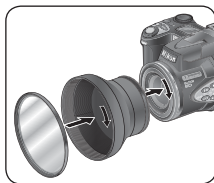

When using the HN-CP11 or HR-E5700, remove the camera lens cap and attach the hood as shown at right. A 77-mm (3") filter can be screwed into the HN-CP11 as shown (note that dust on the filter may be visible in pictures taken at short ranges in macro close-up [ 37] and [ Close up;  26] modes). Filters can not be mounted on the HR-E5700. Remove lens hoods when using the built-in Speedlight or an optional flash accessory mounted on the camera accessory shoe. Failure to observe this precaution could result in the light from the flash being eclipsed by the lens hood.

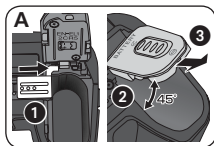

### **The MB-E5700 Battery Pack**

The MB-E5700 takes six AA (LR6) alkaline, lithium, NiCad, or NiMH batteries and can be used to power the camera for extended shooting or playback. Before attaching the battery pack, remove the battery pack connector and battery-chamber covers. To remove the battery pack connector cover, slide it in the direction shown (A-). The battery-chamber cover can be removed by opening it to an angle of about 45° (A-), when it can easily be removed as shown (A-). Do not attempt to remove the battery-chamber cover without first removing the battery pack connector cover; failure to observe this precaution could result in damage to the camera.



To replace the battery pack connector and battery-chamber covers when the battery pack is not in use, insert the battery-chamber cover at an angle of about 45° (B-) and slide the battery pack connector cover into place (B-). See the MB-E5700 instruction manual for details.

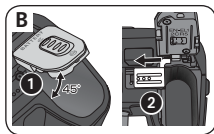



## Approved Memory Cards

The following cards have been tested and approved for use with the COOLPIX 8700:

Nikon	EC-CF	All capacities
SanDisk	CompactFlash (SDCFB)	32 MB, 64 MB, 128 MB, 256 MB, 512 MB
	Ultra (SDCFH)	128 MB, 256 MB, 512 MB
	Ultra II (SDCFH)	256 MB
Lexar Media	4 × USB	16 MB, 32 MB, 64 MB, 128 MB, 256 MB, 512 MB
	8 × USB	
	12 × USB	64 MB, 128 MB, 256 MB, 512 MB
	16 × USB	
	24 × USB	
24 × WA USB		
Renesas Technology (Hitachi)	Compact FLASH HB28	128 MB, 256 MB, 512 MB
Microdrive	DSCM	10512 (512 MB), 11000 (1 GB)

Operation is not guaranteed with other makes of card. For more details on the above cards, please contact the manufacturer.

### Memory Cards

- Memory cards may be hot after use. Observe due caution when removing memory cards from the camera.
- Format memory cards before first use.
- Turn the power off before inserting or removing memory cards. Do not remove memory cards from the camera, turn the camera off, or remove or disconnect the power source during formatting or while data are being recorded, deleted, or copied to a computer. Failure to observe these precautions could result in loss of data or in damage to the camera or card.
- Do not touch the card terminals with your fingers or metal objects.
- Do not apply force to the card casing. Failure to observe this precaution could damage the card.
- Do not bend, drop, or subject to strong physical shocks.
- Do not expose to water, heat, high levels of humidity, or direct sunlight.

## Caring for Your Camera



To ensure continued enjoyment of your Nikon product, observe the following precautions when storing or using the device:

- ✔ **Keep dry**  
The device will be damaged if immersed in water or subjected to high levels of moisture.
- ✔ **Handle the lens and all moving parts with care**  
Do not apply force to the lens, monitor, or to the connector, card slot, or battery chamber covers. These parts are especially susceptible to damage.
- ✔ **Do not point the lens at strong light sources for extended periods**  
Avoid pointing the lens at the sun or other strong light sources for extended periods when using or storing the camera. Intense light may cause deterioration in the CCD image sensor, producing a white blur effect in photographs.
- ✔ **Turn the product off before removing or disconnecting the power source**  
Do not unplug the product or remove the batteries while the product is on, or while images are being recorded or deleted. Forcibly cutting power in these circumstances could result in loss of data or in damage to product memory or internal circuitry. To prevent an accidental interruption of power, avoid carrying the product from one place to another while the AC adapter (available separately) is connected.
- ✔ **Do not drop**  
The product may malfunction if subjected to strong shocks or vibration.
- ✔ **Keep away from strong magnetic fields**  
Do not use or store this device in the vicinity of equipment that generates strong electromagnetic radiation or magnetic fields. Strong static charges or the magnetic fields produced by equipment such as radio transmitters could interfere with the monitor, damage data stored on the memory card, or affect the product's internal circuitry.
- ✔ **Avoid sudden changes in temperature**  
Sudden changes in temperature, such as occur when entering or leaving a heated building on a cold day, can cause condensation inside the device. To prevent condensation, place the device in a carrying case or a plastic bag before exposing it to sudden changes in temperature.
- ✔ **The AF-Assist Illuminator LED**  
The light-emitting diode (LED) used in the AF-assist illuminator conforms to the following IEC standard:

**CLASS 1 LED PRODUCT**

IEC60825-1 Edition 1.2<sup>2001</sup>

## Cleaning

### *Lens/Electronic Viewfinder*

One key to preserving the condition of these glass parts is to not touch them with your fingers. Remove dust or lint with a *blower* (typically a small device with a rubber bulb attached to one end that is pumped to produce a stream of air out the other). To remove fingerprints or other stains that can not be removed with a blower, wipe the lens or viewfinder with a soft cloth, using a spiral motion that starts in the center of the lens and works out to the edges.

### *Monitor*

Remove dust or lint with a blower. To remove fingerprints and other stains, clean the monitor with a soft, dry cloth, being careful not to apply pressure.

#### *Avoid contact with liquid crystal*

Should the monitor or electronic viewfinder break, care should be taken to avoid injury due to broken glass and to prevent the liquid crystal from the monitor touching the skin or entering the eyes or mouth.

---

### *Body*

Use a blower to remove dust and lint, then wipe gently with a soft, dry cloth. After using the camera at the beach or seaside, wipe off any sand or salt with a cloth lightly dampened with fresh water, then dry thoroughly.

***Do not use alcohol, thinner, or other volatile chemicals.***

#### **Notes on the Monitor and Electronic Viewfinder**

- The monitor and electronic viewfinder may contain a few pixels that are always lit or that do not light. This is a characteristic common to all TFT LCD displays, and does not indicate a malfunction. Images recorded using the product will not be affected.
- When you frame bright subjects, vertical comet-like streaks that whiten toward either end may appear in the monitor. This phenomenon, known as “smear,” does not appear in the final photograph and does not indicate a malfunction. Some smear may appear in movies.
- Images in the monitor may be difficult to see in a bright light.
- The monitor is lit by an LED backlit. Should the monitor begin to dim or flicker, contact your Nikon service representative.



## Storage

Turn the camera off when not in use and check that the power-on lamp is off before putting the camera away. To prevent mold or mildew, store the camera in a dry, well-ventilated area. If you will not be using the product for long periods, remove the battery to prevent leakage and store the camera in a plastic bag containing a desiccant. Do not store the camera case (available separately) in a plastic bag, as this may cause the material to deteriorate. Note that desiccant gradually loses its capacity to absorb moisture and should be replaced at regular intervals. Do not store the camera with naphtha or camphor moth balls or in locations that:

- are poorly ventilated or damp
- are next to equipment that produces strong electromagnetic fields, such as televisions or radios
- are exposed to temperatures below  $-10^{\circ}\text{C}$  ( $14^{\circ}\text{F}$ ) or above  $50^{\circ}\text{C}$  ( $122^{\circ}\text{F}$ ); for example near a space heater or in a closed vehicle on a sunny day
- are subject to humidities of over 60%

To prevent mold or mildew, take the camera out of storage at least once a month. Turn the camera on and release the shutter a few times before putting the camera away again.









Store the battery in a cool, dry place.



## Batteries

- When turning the camera on, check that the battery is charged. The monitor will display a warning when batteries are low.
- For increased battery life, switch to the electronic viewfinder after shooting.
- Carry a fresh 2CR5 or a fully-charged spare EN-EL1 battery as a replacement when taking pictures on important occasions. You may find it difficult to purchase replacement batteries on short notice. Do not use 2CR5 batteries after their expiry date.
- On cold days, the capacity of batteries tends to decrease. Be sure that the battery is fully charged before heading outside to take pictures in cold weather. Keep spare batteries in a warm place and exchange as necessary. Once warmed, a cold battery may recover some of its charge.
- If the battery terminals are dirty, wipe them off with a clean, dry cloth before use.
- Used batteries are a valuable resource. Please recycle used batteries in accordance with local regulations.

## Error Messages

The following table lists the error messages and other warnings that appear in the monitor and how to deal with them.

Display	Problem	Solution	
 (Flashes)	Clock not set.	Set clock to current date and time.	11
NEW CITY IS IN THE CURRENT TIME ZONE	Travel destination is in same time zone as home location.	No need to specify new time zone if travel destination is in same time zone as home location.	124
WARNING !! BATTERY EXHAUSTED	Battery exhausted.	Turn camera off and replace battery.	8
 NO CARD PRESENT	Camera can not detect memory card.	Turn camera off and confirm that memory card is correctly inserted.	10
 THIS CARD CANNOT BE USED	Error accessing memory card.	<ul style="list-style-type: none"> <li>• Use approved card.</li> <li>• Check that connectors are clean.</li> <li>• Turn camera off and confirm that memory card is correctly inserted.</li> </ul>	139
 WARNING !! THIS CF CARD CANNOT BE READ			10
 CARD IS NOT FORMATTED  NO FORMAT 	Memory card has not been formatted for use in camera.	Press multi selector up to highlight <b>FORMAT</b> and press to right to format card, or turn camera off and replace card.	104
 OUT OF MEMORY	<i>Camera in shooting mode:</i> Insufficient memory to record pictures at current settings.	<ul style="list-style-type: none"> <li>• Reduce image quality or size.</li> <li>• Insert new memory card or delete pictures.</li> </ul>	30 10, 106
	<i>Camera connected to computer:</i> Not enough space on memory card to record information need for transfer.	Disconnect camera, delete unwanted pictures, and try again.	67, 106

Display	Problem	Solution	
 IMAGE CANNOT BE SAVED	<ul style="list-style-type: none"> <li>• Memory card has not been formatted for use in camera, or error occurred while saving picture.</li> <li>• Camera has run out of file numbers.</li> <li>• Camera can not copy picture using small picture or crop options.</li> </ul>	<ul style="list-style-type: none"> <li>• Reformat memory card.</li> <li>• Insert new memory card or delete pictures.</li> <li>• Copies can not be created from movies or from other copies.</li> </ul>	104  10, 106 61, 62
CARD CONTAINS NO IMAGES	No pictures on memory card, or current folder contains no images.	To view pictures, select folder containing pictures in <b>Folders</b> menu.	108
ALL IMAGES ARE HIDDEN	All pictures in current folder are hidden.	Select another folder or use <b>Hide image</b> to change hidden status of pictures in current folder.	115
FILE CONTAINS NO IMAGE DATA	File created by computer or different make of camera.	View file on computer or correct make of camera.	65
THIS IMAGE CANNOT BE DELETED	Attempt to delete protected picture.	Remove protection before deleting picture.	114
THE FOLDER CANNOT BE DELETED	Folder contains hidden or protected pictures, or pictures not created with COOLPIX 8700.	Remove hidden or protected marking from pictures. Folder can not be deleted if it contains pictures not created with COOLPIX 8700.	114, 115
SPEEDLIGHT IS IN THE CLOSED POSITION	Speedlight prevented from popping up when required for additional lighting.	Remove finger or other object from Speedlight and press shutter-release button halfway.	17
REMOTE CORD CANNOT BE USED IN THIS MODE	MC-EU1 remote cord connected with <b>Time lapse</b> or	Disconnect remote cord or change <b>Continuous</b> setting.	80
REMOTE CORD CANNOT BE USED IN MOVIE MODE	<b>Movie</b> selected for <b>Continuous</b> .		

Display	Problem	Solution	
LENS ERROR	Error has occurred during lens operation.	Turn camera off and then on again. If error persists, contact retailer or Nikon service representative.	—
SYSTEM ERROR	Error has occurred in camera's internal circuitry.*	Turn camera off, unplug optional AC adapter (if using), remove and reinsert batteries, and turn camera on. If error persists, contact retailer or Nikon representative.	8

\* The letters **Err** appear in the control panel when a system error has occurred.

# Troubleshooting





If your camera fails to function as expected, check the list of common problems below before consulting your retailer or Nikon representative. Refer to the page numbers listed in the right-most column for information on solving the problems listed here.

## Electronically-Controlled Cameras

In extremely rare instances, unusual characters may appear in the monitor and the camera may stop functioning. In most cases, this phenomenon is caused by a strong external static charge. Turn the camera off, remove and replace the batteries, and turn the camera on again, or, if you are using an AC adapter (available separately), disconnect and reconnect the adapter, and turn the camera on again. In the event of continued malfunction, contact your retailer or Nikon representative. Note that disconnecting the power source as described above may result in the loss of any data not recorded to the memory card at the time the problem occurred. Data already recorded to the memory card will not be affected.

Problem	Solution	
Camera turns off without warning	<ul style="list-style-type: none"><li>• Batteries are low.</li><li>• Batteries are cold.</li></ul>	14 142
Control panel is blank	<ul style="list-style-type: none"><li>• Camera is off.</li></ul>	7
	<ul style="list-style-type: none"><li>• Batteries are not correctly inserted or battery-chamber cover is not properly latched.</li></ul>	8
	<ul style="list-style-type: none"><li>• Batteries are exhausted.</li></ul>	14
	<ul style="list-style-type: none"><li>• AC adapter (available separately) is not properly connected.</li></ul>	—
	<ul style="list-style-type: none"><li>• Camera is in energy-saving mode. Press shutter-release button halfway.</li></ul>	17
	<ul style="list-style-type: none"><li>• Camera is shooting time-lapse movie.</li><li>• Interval-timer shooting in progress.</li></ul>	53 83
Monitor is blank	<ul style="list-style-type: none"><li>• Electronic viewfinder is on. Press  button.</li></ul>	4
	<ul style="list-style-type: none"><li>• Lens cap is on. Remove lens cap.</li></ul>	—
	<ul style="list-style-type: none"><li>• USB cable is connected. Disconnect USB cable.</li></ul>	66
	<ul style="list-style-type: none"><li>• A/V cable is connected. Disconnect A/V cable.</li></ul>	64
	<ul style="list-style-type: none"><li>• MC-EU1 remote cord is connected in standby mode.</li></ul>	—
	<ul style="list-style-type: none"><li>• Camera is shooting time-lapse movie.</li><li>• Interval-timer shooting in progress.</li></ul>	53 83
No indicators appear in monitor	<ul style="list-style-type: none"><li>• Indicators are hidden. Press  button until indicators are displayed.</li></ul>	4, 55
	<ul style="list-style-type: none"><li>• Slide show is in progress.</li></ul>	112



Problem	Solution	
Monitor is hard to read	<ul style="list-style-type: none"> <li>• Ambient lighting too bright: use electronic viewfinder.</li> <li>• Monitor brightness needs adjustment.</li> <li>• Monitor is dirty: clean monitor.</li> </ul>	4 127 141
No picture is taken when shutter-release button is pressed	<ul style="list-style-type: none"> <li>• Camera is in playback mode.</li> <li>• Batteries are exhausted.</li> <li>• Number of exposures remaining is zero: insufficient memory to record picture at current image quality and size settings.</li> <li>• Flash indicator blinks: flash is charging.</li> <li>• Message "CARD IS NOT FORMATTED" appears in monitor: memory card is not formatted for use in camera.</li> <li>• Message "NO CARD PRESENT" appears in monitor: no memory card in camera.</li> </ul>	55 14 14 18 104 10
Pictures are too dark (underexposed)	<ul style="list-style-type: none"> <li>• Flash is off.</li> <li>• Flash window is blocked.</li> <li>• Subject is outside range of flash.</li> <li>• Exposure compensation is too low.</li> <li>• Shutter speed blinks: shutter speed too fast.</li> <li>• Aperture blinks: f/-number too high.</li> </ul>	34 16 150 39 42 43
Pictures are too bright (overexposed)	<ul style="list-style-type: none"> <li>• Exposure compensation is too high.</li> <li>• Shutter speed blinks: shutter speed too slow.</li> <li>• Aperture blinks: f/-number too low.</li> </ul>	39 42 43
Pictures are out of focus	<ul style="list-style-type: none"> <li>• Subject not in focus area when shutter-release button was pressed halfway or  button was pressed.</li> <li>• Camera can not focus on selected subject using autofocus. Use focus lock.</li> </ul>	18 20
Pictures are blurred	<ul style="list-style-type: none"> <li>• Camera shook during shot: choose faster shutter speed. If shutter speed can not be increased without causing underexposure:                             <ul style="list-style-type: none"> <li>◆ Use flash</li> <li>◆ Zoom camera out</li> <li>◆ Raise sensitivity (ISO equivalency)</li> <li>◆ Select larger aperture (smaller f/-number)</li> </ul> </li> <li>To minimize blur at slow shutter speeds:                             <ul style="list-style-type: none"> <li>◆ Use Best Shot Selector (BSS)</li> <li>◆ Mount camera on tripod and use self-timer</li> </ul> </li> </ul>	40 34 16 46 40 84 36
Pictures contain randomly-spaced bright pixels ("noise")	<ul style="list-style-type: none"> <li>• Sensitivity (ISO equivalency) too high.</li> <li>• Shutter speed too slow. At shutter speeds of 1/4 s or slower, turn noise reduction on.</li> </ul>	46 101

Problem	Solution	
Flash does not fire	• Flash is off. Flash turns off automatically when:	34
	◆ Focus mode is set to ▲ (infinity)	37
	◆ Landscape, Sunset, Night landscape, Fireworks show, Close up, Copy, or Panorama assist selected in scene mode	23
	◆ <b>Continuous</b> is set to option other than <b>Single</b>	80
	◆ BSS or AE-BSS is on	84
	◆ <b>Lens</b> is set to option other than <b>Normal</b>	90
Digital zoom unavailable	◆ <b>Speedlight cntrl</b> is set to <b>Internal off</b>	97
	◆ Optional Speedlight is attached and <b>Speedlight cntrl</b> set to <b>Auto</b>	97
Colors are unnatural	• Image quality set to RAW or HI.	30
	• <b>Multi-shot 16</b> or <b>Ultra HS</b> selected for <b>Continuous</b> .	80
	• <b>Black&amp;white</b> selected for <b>Saturation control</b> .	87
	• <b>Wide adapter</b> or <b>Fisheye</b> selected for <b>Lens</b> .	90
File can not be played back	• <b>Off</b> selected for <b>Zoom options&gt;Digital tele</b> .	95
	• White balance does not match light source.	76
Can not create copy using small picture or crop options	• Color saturation is too low or too high.	87
	File has been overwritten or renamed by computer or other make of camera.	—
	• Picture is a movie.	49
Can not zoom in on picture	• Picture is a resized or cropped copy.	61, 62
	• Space remaining on memory card is insufficient. Delete pictures.	106
	• Picture was created with small picture option.	62
No picture displayed on TV	• Picture has been cropped to below 320 × 240.	61
	A/V cable not correctly connected, TV not tuned to video channel, or <b>Video mode</b> not set correctly.	64, 135
	• Camera is off.	7
PictureProject does not start when camera is connected or memory card inserted in card reader or card slot	• AC adapter (available separately) is not properly connected, or batteries are exhausted.	14
	• USB cable is not correctly connected, or card not properly inserted in card reader or card slot.	10, 66
	• <b>USB</b> item in setup menu set to <b>PTP</b> when camera connected to computer running Windows 2000 Professional, Windows Millennium Edition (Me), or Windows 98 Second Edition (SE).	65
	• Camera is not registered in Device Manager (Windows only). See <i>PictureProject Reference Manual</i> (on CD) for further information.	—

# Specifications



Type	E8700 digital camera
Effective pixels	8.0 million
CCD	$\frac{2}{3}$ " high-density CCD; total pixels: 8.31 million
Image size (pixels)	<ul style="list-style-type: none"> <li style="width: 33%;">• 3,264 × 2,448 (8M)</li> <li style="width: 33%;">• 3,264 × 2,176 (3:2)</li> <li style="width: 33%;">• 2,592 × 1,944 (5M)</li> <li style="width: 33%;">• 2,048 × 1,536 (3M)</li> <li style="width: 33%;">• 1,600 × 1,200 (2M)</li> <li style="width: 33%;">• 1,280 × 960 (1M)</li> <li style="width: 33%;">• 1,024 × 768 (PC)</li> <li style="width: 33%;">• 640 × 480 (TV)</li> </ul>
Lens	8 × Zoom Nikkor
Focal length	F=8.9–71.2 mm (35-mm [135] camera-format equivalent: 35–280 mm)
f/-number	f/2.8–f/4.2
Construction	14 elements in 10 groups
Digital zoom	Up to 4 × (35-mm [135] camera-format equivalent: 1120 mm)
Autofocus (AF)	Contrast-detect through-the-lens (TTL) AF with AF-assist illuminator
Focus range	50 cm (1'8")–∞; 3 cm (1.2")–∞ in macro and manual focus modes (middle zoom position)
Focus-area selection	Five-area multi AF; manual selection available
AF-assist illuminator	Class 1 LED product (IEC60825-1 Edition 1.2 <sup>2001</sup> ); max. output: 1150 μW
Viewfinder	0.44", 235,000-dot, polysilicon TFT color LCD viewfinder
Magnification	0.27–2.1 ×
Frame coverage	Approximately 97% horizontal and 97% vertical
Diopter adjustment	–4 +1 m <sup>-1</sup>
Monitor	1.8", 134,000-dot, High Transmissive Advanced TFT LCD monitor with brightness and hue adjustment
Frame coverage	Approximately 97% horizontal and 97% vertical (shooting)
<b>Exposure</b>	
Metering	Four mode through-the-lens (TTL) metering: <ul style="list-style-type: none"> <li style="width: 50%;">• 256-segment matrix</li> <li style="width: 50%;">• Spot</li> <li style="width: 50%;">• Center-weighted</li> <li style="width: 50%;">• Spot AF area</li> </ul>
Exposure control	Programmed auto exposure with flexible program, shutter-priority auto, aperture-priority auto, manual, exposure compensation (–2.0 +2.0 EV in $\frac{1}{3}$ EV steps), autoexposure bracketing, AE-BSS
Range	W: –1.0 +19.0 EV                      T: +0.5 +19.0 EV
Shutter	Mechanical and charge-coupled electronic shutter
Speed	2– $\frac{1}{4},000$ s (auto and exposure mode <b>P</b> ), 8– $\frac{1}{4},000$ s (exposure modes <b>S</b> and <b>A</b> ), BULB/TIME (max. 10 min.) and 8– $\frac{1}{4},000$ s (exposure mode <b>M</b> ), $\frac{1}{30}$ – $\frac{1}{8},000$ s (Ultra HS). Maximum at some apertures is $\frac{1}{2},000$ s.
Aperture	Seven-blade iris diaphragm.
Range	Ten settings in steps of $\frac{1}{3}$ EV (to minimum of f/8)

<b>Sensitivity</b>	Approximately equivalent to ISO 50, 100, 200, 400; Auto (auto gain to ISO 200 equivalent)
<b>Self-timer</b>	10- or 3-second duration
<b>Built-in Speedlight</b>	
<b>Range (Auto ISO)</b>	W: 0.5–4.1 m/1'8"–13'5"      T: 0.5–2.7 m/1'8"–8'10"
<b>Sync method</b>	Automatic sync control
<b>Accessory shoe</b>	Standard ISO hot-shoe contact with safety lock
<b>Sync contact</b>	X-contact only
<b>Storage</b>	
<b>Media</b>	Type I and II CompactFlash™ (CF) and Microdrive cards
<b>File system</b>	Compliant with Design Rule for Camera File System (DCF)*, Exif 2.2†, and Digital Print Order Format (DPOF)
<b>File formats</b>	Uncompressed: RAW (NEF), TIFF-RGB Compressed: JPEG-baseline-compliant (1:4, 1:8, 1:16) Movies: QuickTime    Sound files: WAV
<b>Interface</b>	USB
<b>Video output</b>	Can be selected from NTSC and PAL
<b>I/O terminals</b>	DC in; audio/video (A/V) out; digital I/O (USB)
<b>Power sources</b>	<ul style="list-style-type: none"> <li>• One rechargeable Nikon EN-EL1 lithium-ion battery (supplied)</li> <li>• MB-E5700 battery pack (available separately) with six AA (LR6) alkaline, lithium, NiCad, or NiMH batteries</li> <li>• One 2CR5 (DL245) lithium battery (available separately)</li> <li>• EH-53 AC adapter (available separately)</li> </ul>
<b>Approximate battery life</b>	210 shots (EN-EL1)/240 shots (2CR5). Measured at 25°C/77°F with fully-charged batteries under standard Nikon test conditions: monitor on, zoom adjusted with each shot, flash used about once every three shots, image quality set to <b>Normal</b> .
<b>Dimensions</b>	113 × 78 × 105 mm/4.45" × 3.07" × 4.13" (W × H × D)
<b>Approximate weight</b>	480 g (1 lb 1 oz) without battery or memory card
<b>Operating environment</b>	
<b>Temperature</b>	0–40°C (32–104°F)
<b>Humidity</b>	Less than 85% (no condensation)

\* A standard widely used in the digital camera industry to ensure compatibility among different makes of camera.

† Exchangeable Image File Format for Digital Still Cameras. Version 2.2 allows information stored with pictures to be used for optimal color reproduction when images are output on Exif-compliant printers.

## Symbols

- 15
- 50, 100, 200, 400, 46**
- 8M**, **3M**, **2M**, **1M**, **PC**, **TV**, **3.2**, 32–33
- (auto) mode, 14–20
- see Mode selector
- see Mode selector
- button, 30–33
- button, 34–36
- button, 37, 38, 47
- button, 39, 63
- button, 21, 48, 55
- button, 4, 128
- Q** and buttons, 16, 57, 60
- 14
- 12
- 23–29
- 34–36
- 37, 38
- 39
- DELETE**, 48
- A-WB, PRE** 76–78
- 79
- 80–83
- A** 86
- 87
- 90
- 89
- 63
- 114
- 115
- 116–117
- 118–119
- 120–121

## A

- A**, see Exposure mode
- Accessory shoe, 2, 96
- AC adapter, 9, 137
- AE-L**, 20, 133
- AE-L, AF-L**, 133
- AE/AF lock button, 20, 133
- AE lock**, 20, 133
- AF, see Autofocus

- AF see Focus indicator
- AF area mode**, 93
- AF-assist illuminator, 19
- Aperture, 40–45
- Audio, see Movies, Voice memo
- Audio/video out connector, 64
- Auto-focus mode**, 94
- Autofocus, 18
- Auto bracketing**, 99–100
- Auto off**, 17, 131
- Auto transfer**, 118–119

## B

- Back light**, 27
- Backlit subjects, 27, 34
- BASIC, 30
- Batteries, 8–9, 14
  - 2CR5 (DL245), 8–9
  - EN-EL1, 8–9
    - charging, 8
- Beach/Snow**, 25
- Best Shot Selector, see BSS
- Black-and-white, 87
- Blur, 24, 84, 147
- Brightness**, 127
- BSS**, 84–85
- BSS**, **AE**, 84–85
- BULB**, see **Bulb/Time**, Long time-exposures
- Bulb/Time**, 92

## C

- Camera strap, ii, 2
- CF card, see Memory card
- CF card format**, 104
- Clock, see **Date**
- Close ups**, 26
- Command dial, 2
- CompactFlash™, see Memory cards
- Compression, see Image quality
- Computer, 65–67. See also E-mail, Printing pictures, Transfer
  - copying pictures to, 65–67
- Continuous**, 80–83



- Contrast, see **Image adjustment**
- Controls**, 132–133
- Copy**, 27
- Copying pictures, see **Move image**, Transfer
- Cropped copies, 60–61

## D

- Date**, 12–13, 124–125
  - DATE**, **DATE**, **DATE**, 136
  - Date, 12–13, 68, 124–125
    - printing on pictures, 68, 117
- Date imprint**, 136
- DCF, 150
- Delete**, 106–107
- Deleting pictures, 21, 48, 55, 106–107
  - all pictures, 107
  - during shooting, 21, 48
  - in full-frame playback, 55
  - selected pictures, 106
  - with folder, 110
- Design Rule for Camera File System, see DCF
- Digital Print Order Format, see DPOF
- Digital tele**, 95
- Diopter adjustment, 17
- DBP** button, 4, 55
- DPOF, 68
- DPOF via direct USB connection, 69–73

## E

- E-mail, 32, 62
- Exif 2.2, 150
- Exif Print, see Exif 2.2
- Exposure bracketing, 99–100
- Exposure BSS**, 84–85
- Exposure compensation, 39
- Exposure information, see Photo information
- Exposure lock, 20
- Exposure metering, see Metering
- Exposure mode, 40–45
- Exposure options**, 91–92

- F**  
 Files, see Image files  
 File numbering, 22, 129  
 Fill flash, 34–35  
 FINE, 30  
**Fireworks show**, 26  
 Firmware, 136  
**Firmware version**, 136  
**Fixed aperture**, 95  
 Flash, 34–36, 96–98  
   built-in, 2, 34–36  
   mode, 34–36  
   optional, 97–98, 137  
   range, 35  
**Flash exp. comp.**, 96  
 Flash exposure compensation, 96  
 Flash indicator, 18  
 Flexible program, 41  
 Focus, 37, 93–94  
 Focus area, 24–27, 93  
**Focus confirmation**, 94  
 Focus indicator, 18  
 Focus information, see **Focus confirmation**, Photo information  
 Focus lock, 20  
 Focus mode, 37, 38  
**Focus options**, 93–94  
**Folders**, 108–111, 126  
   choosing for playback, 111  
   creating, 108  
   deleting, 110  
   renaming, 109  
   storing pictures in, 126  
 Formatting, see Memory card, formatting  
 Framing guides, 16–17  
 Framing pictures, 16–17  
**FUNC**, 132  
 button, 15, 132
- H**  
 Hi, 30, 56  
 Hidden pictures, 107, 112, 115  
**Hide image**, 115  
**Hue**, 127
- I**  
**Image adjustment**, 86  
 Image files, 22  
 Image quality, 30–31, 33  
**Image sharpening**, 89  
 Image size, 30, 32–33  
 Infinity, see Focus mode, Manual focus  
**info.txt**, 134  
 Information, see Photo information  
 Interval timer photography, 80, 82–83  
 ISO, see Sensitivity
- J**  
 JPEG, 22, 30, 150  
 JPG, 22, 30, 150
- L**  
**Landscape**, 25  
**Language**, 11–12, 124  
 Language, choosing, 11–12, 124  
 Lens, 2, 16, 90, 137–138  
**Lens**, 90  
 Lens, converter, 90, 137  
 Lens adapter ring, 90, 137  
 button, see AE/AF lock button  
 Long time-exposures, 45, 92
- M**  
**M**, see Exposure mode  
 Macro close-up, 37  
 Manual focus, 47  
 Memory cards, 10–11, 104, 139  
   approved, 139  
   formatting, 104  
   insertion and removal of, 10–11  
 button, 74  
**Metering**, 79  
 MF button, 47  
 Microdrive, see Memory cards  
 Microphone, built in, 2, 49, 63  
 Mode selector, 14, 55  
 Monitor, 3, 4, 5, 126–128  
   brightness and hue, 127  
   framing pictures in, 16  
   indicators in, 5  
   opening and closing, 4  
**Monitor options**, 126–128  
 Monochrome, see Black-and-white  
 MOV, 22, 49–54  
**Move image**, 120–121  
 Movies, 49–54  
   recording, 51–53  
   viewing, 54  
 Movie mode, 49–54  
 Movie options, 49–50  
 Moving pictures, 120–121  
 Multi selector, 7  
**My menu**, 74, 103
- N**  
 NEF, 22, 30–31, 33, 56, 150  
**Night landscape**, 26  
**Night portrait**, 25  
 Nikon Capture, 31  
 Noise, 27, 45, 46, 101  
 Noise reduction, 27, 101  
**Noise reduction**, 101  
 NORM (NORMAL), 30  
 NR, 101  
 NTSC, see Video mode  
 Number of exposures remaining, 5, 14
- O**  
 On/off, see Power switch
- P**  
**P**, see Exposure mode, PAL, see Video mode  
 Panorama, 22, 27, 28–29  
**Panorama assist**, 27, 28–29  
**Party/Indoor**, 24  
 Photo information, 58–59  
 PictBridge, 68–73  
 PLAYBACK MENU, 105–121  
 Playback mode, 21, 54, 55–63  
 Playing pictures back, 21, 54, 55–63  
   full frame, 55  
   in quick review, 21  
   movie playback, 54

on a computer, 65–67  
 on a TV, 64  
**Portrait**, 24  
 Power switch, 2, 7  
 Printing pictures, 68–73. *See also* **Date imprint**, DPOF  
 via direct USB connection  
**Print set**, 116–117  
 Print size, 32  
**Protect**, 114  
 Protected pictures, 104, 107,  
 110, 114  
**Q**  
 Quality, *see* Image quality  
 button, 21  
 Quick review, 21  
 QuickTime, *see* Movies  
**R**  
 RAW, 22, 30–31, 33, 56, 150  
 converting to TIFF, 56  
 Red-eye reduction, 34  
**Release speed**, 126  
**Reset**, 102  
**Reset all**, 135  
 Resizing pictures, 62, 121  
**Review options**, 127  
**S**  
**S**, *see* Exposure mode  
**Saturation control**, 87  
 SB●, *see* Flash indicator  
 Scene mode, 23–29  
 Self-portraits, 4, 37, 38  
 Self-timer, 37, 38  
 Self-timer lamp, 2, 38  
 Sensitivity, 36, 46  
**Sepia movie 320**, 49–51,  
 54, 87  
**Seq. numbers**, 129  
 SET-UP menu, 122–136  
 SHOOTING menu, 74–104  
**Shot confirmation**, 133  
**Show all menus**, 74  
 Shutter-release button, 2, 7  
 Shutter-release delay, *see* Self-  
 timer  
**Shutter sound**, 130

Shutter speed, 40–45  
**Slide show**, 112–113  
 Slide shows, 112–113  
**Small pic**, 121  
 Smear, 141  
 Speaker, built-in, 3, 54, 63  
 Speedlight, *see* Flash  
**Speedlight cntrl**, 97  
**Speedlight opt.**, 96–98  
 Standby mode, 17, 131  
**Start-up display**, 128  
**Sunset**, 25  
 Support information, 1  
**T**  
 Telephoto, *see* Zoom  
 Television, 64  
 connecting to, 64  
 Thumbnail playback, 57  
 TIF, 22, 30–31, 33, 56, 150  
 TIFF, 22, 30–31, 33, 56, 150  
 Time-lapse movies, 49–50,  
 52–53, 54  
 Time zone, 12–13, 124–125  
 Timer, *see* Interval timer pho-  
 tography, Self-timer  
 Transfer, 65–67, 118–119  
 marking pictures for,  
 118–119  
 Tripod, 3, 24, 29, 45, 147  
 button, *see* Zoom, buttons  
**U**  
**USB**, 65, 134  
 USB, 65–67, 69–73, 134  
 cable (UC-E1), 65–66, 69  
 direct print, 69–73  
**User setting**, 15, 23, 40, 88  
**V**  
 VCR, 64  
 Video cable (EG-E5000), 64  
**Video mode**, 64, 135  
 Viewfinder, 18  
 framing pictures in, 16  
 Voice memos, 63  
 Volume, 54, 63

**W**  
 WAV, 22, 63, 150  
**Welcome screen**, 128–129  
 White balance, 76–78  
 bracketing, 99  
 fine tuning, 77  
 preset, 78  
 Wide angle, *see* Zoom  
 button, *see* Zoom, buttons  
**Z**  
 Zoom, 16, 95  
 buttons, 16  
 digital, 16, 95  
 indicator, 16  
 optical, 16, 95  
 playback, 60–61  
**Zoom options**, 95

# **Nikon**

No reproduction in any form of this manual, in whole or in part (except for brief quotation in critical articles or reviews), may be made without written authorization from NIKON CORPORATION.

**NIKON CORPORATION**

Fuji Bldg., 2-3 Marunouchi 3-chome,  
Chiyoda-ku, Tokyo 100-8331, Japan

Printed in Japan

SB4C04(11)

6MA00111-A